



Manual

1. Start

2. Basics

- [2.1 Adding files](#)
- [2.2 Selecting files](#)
- [2.3 Selecting a disc recorder](#)
- [2.4 Disc recording status](#)
- [2.5 Selecting a drive](#)
- [2.6 Acquiring images](#)
 - [2.6.1 From Internet](#)
 - [2.6.2 From cover search \(Internet search\)](#)
- [2.7 Editing text](#)
- [2.8 Editing shapes](#)
- [2.9 Editing tables](#)

3. Burn Data

- [3.1 New Disc](#)
- [3.2 New Disc + Disc Spanning](#)
- [3.3 New Disc + Autostart](#)
 - [3.3.1 Interactive Menu](#)
 - [3.3.1.1 Setting the splash screen](#)
 - [3.3.1.2 Editing the design](#)
 - [3.3.2 Autoplay](#)
 - [3.3.2.1 File selection](#)
- [3.4 New Encrypted Disc](#)
- [3.5 Create disc with scratch protection](#)
- [3.6 Restore disc](#)
- [3.7 Update Disc](#)

4. Audio + Music

- [4.1 Create Audio CD](#)
 - [4.1.1 Equalizer effects](#)
 - [4.1.2 Normalization](#)
 - [4.1.3 Pauses](#)
- [4.2 Create MP3 or WMA Disc](#)
 - [4.2.1 Adding audio files](#)
 - [4.2.2 Conversion status](#)
- [4.3 Copy Music Files to Disc](#)
- [4.4 Rip Audio CD](#)
 - [4.4.1 Selecting tracks](#)
 - [4.4.2 Settings](#)
 - [4.4.3 Ripping status](#)

[4.4.4 Quick Rip Audio CD](#)

[4.4.5 Reduce number of files](#)

[4.5 Audiobook](#)

[4.5.1 Create Audiobook](#)

[4.6 Create audio disc for car / player](#)

[4.6.1 My radio isn't available](#)

[4.6.1.1 Create copy from](#)

[4.6.2 Select destination](#)

[4.6.2.1 Add files](#)

5. Movie + Slideshow

[5.1 Create Movie / Slideshow DVD](#)

[5.1.1 Selecting a format](#)

[5.1.2 Adding videos](#)

[5.1.2.1 Create / Edit Movie](#)

[5.1.2.2 Edit blank item](#)

[5.1.2.3 Define start- / endtime](#)

[5.1.2.4 Cut areas](#)

[5.1.2.5 Split video](#)

[5.1.2.6 Adjusting transitions](#)

[5.1.2.7 Adding music](#)

[5.1.2.8 Movie settings](#)

[5.1.2.9 Create Slideshow](#)

[5.1.2.10 Settings](#)

[5.1.2.11 Add files](#)

[5.1.2.12 Create/Edit slideshow](#)

[5.1.2.13 Edit slide](#)

[5.1.2.14 Picture settings](#)

[5.1.2.15 Timeline](#)

[5.1.2.16 Move item](#)

[5.1.2.17 Edit subtitle element](#)

[5.1.2.18 Add multiple images](#)

[5.1.2.19 Add blank item](#)

[5.1.2.20 Record](#)

[5.1.2.21 Show picture information](#)

- [5.1.2.22 Opening/Closing credits](#)
- [5.1.2.23 Select type](#)
- [5.1.2.24 Select background](#)
- [5.1.2.25 Contents: Large scrolling page](#)
- [5.1.2.26 Contents: Multiple fading pages](#)
- [5.1.2.27 Transition](#)
- [5.1.2.28 Music](#)
- [5.1.2.29 Select transition](#)
- [5.1.2.30 Themes](#)
- [5.1.2.31 Settings: View](#)
- [5.1.2.32 Settings: Duration](#)
- [5.1.3 Creating menus](#)
 - [5.1.3.1 Editing the design](#)
 - [5.1.3.2 Editing properties](#)
 - [5.1.3.3 Editing buttons](#)
 - [5.1.3.4 Editing video previews](#)
 - [5.1.3.5 Editing background music](#)
 - [5.1.3.6 Adding pages](#)
 - [5.1.3.7 Editing pages](#)
- [5.1.4 Selecting a target](#)
- [5.1.5 Encoding](#)
- [5.2 Create Movie / Slideshow Blu-ray](#)
 - [5.2.1 Selecting a format](#)
- [5.3 Video DVD from Folder](#)
- [5.4 Video Blu-ray from Folder](#)
- [5.5 Video CD \(VCD\)](#)
- [5.6 Super Video CD \(SVCD\)](#)
- 6. Covers + Inlays**
 - [6.1 Edit paper formats](#)
 - [6.1.1 Copy / New / Edit](#)
 - [6.1.1.1 Defining items](#)
 - [6.1.1.2 Defining measures](#)
 - [6.1.1.3 Summary](#)
 - [6.2 Change Disc Radius](#)
- [6.3 Editing titles](#)
 - [6.3.1 Edit entry](#)
- [6.4 Creating a design](#)
 - [6.4.1 Mosaic cover](#)
 - [6.4.2 Creating / Editing templates](#)
- [6.5 Printing covers](#)
- [6.6 After printing](#)
- 7. Copy Disc**
 - [7.1 Reading status](#)
- 8. Disc Image**
 - [8.1 Burn Image](#)
 - [8.2 Create Image](#)
 - [8.2.1 Write status](#)
 - [8.3 Browse Image](#)
 - [8.3.1 Selecting files](#)
- 9. Backups**
 - [9.1 Backup Files](#)
 - [9.1.1 Selecting backup settings](#)
 - [9.2 Manage Backups](#)
 - [9.2.1 Restore files](#)
 - [9.2.1.1 Settings](#)
 - [9.3 Backup External Devices](#)
 - [9.3.1 Create a new backup](#)
 - [9.3.1.1 Scanning files](#)
 - [9.3.2 Update an existing backup](#)
- 10. Advanced Functions**
 - [10.1 Create a modified copy](#)
 - [10.2 Create a Data Disc using advanced settings](#)
 - [10.3 Erase rewritable Disc](#)
 - [10.3.1 Status](#)
 - [10.4 Finalize Disc](#)
 - [10.5 Analyze Medium](#)
 - [10.6 Statistics](#)
- 11. Settings**
 - [11.1 General Options](#)
 - [11.2 Change Skin](#)
- 12. Service**

1. Start

Ashampoo Burning Studio 25 supports two navigation modes: carousel and menu-based.

Use the  button to switch between them.

Carousel mode

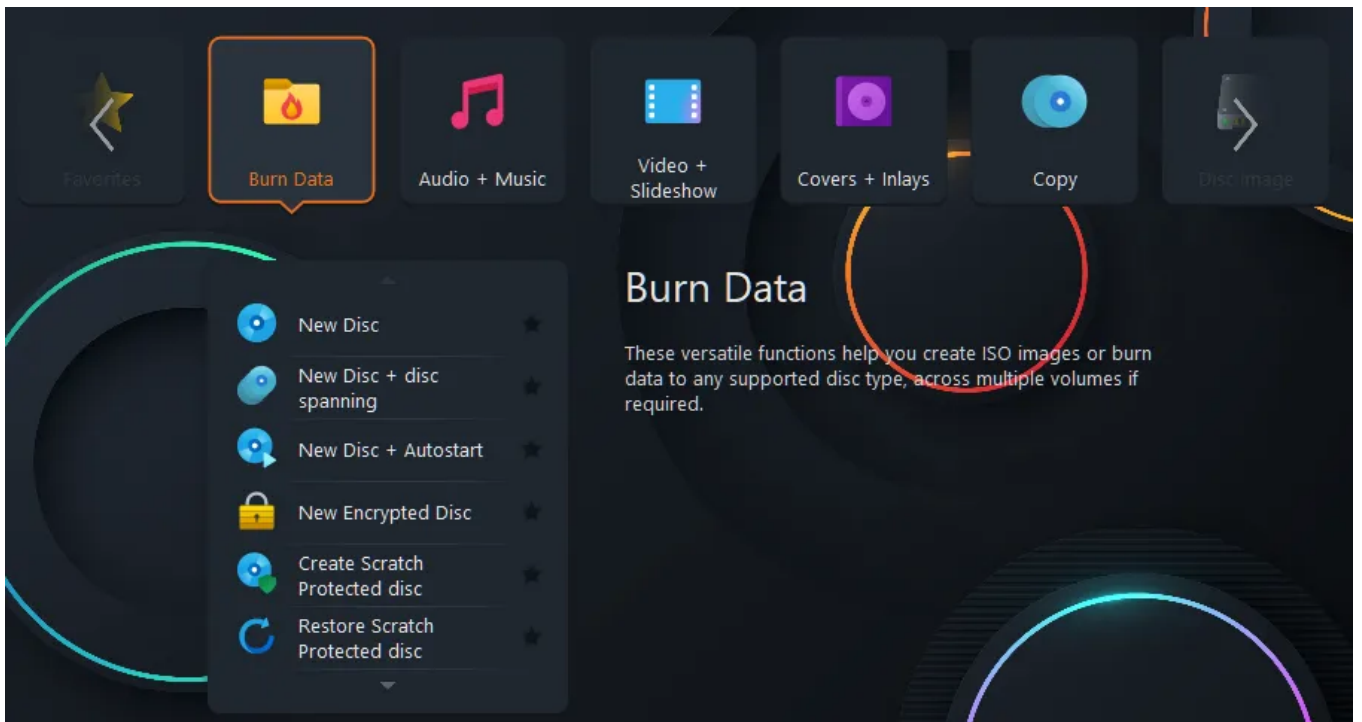

In this mode, program modules appear as separate tiles.

Hover your mouse pointer over a tile to display a brief summary of the features contained.

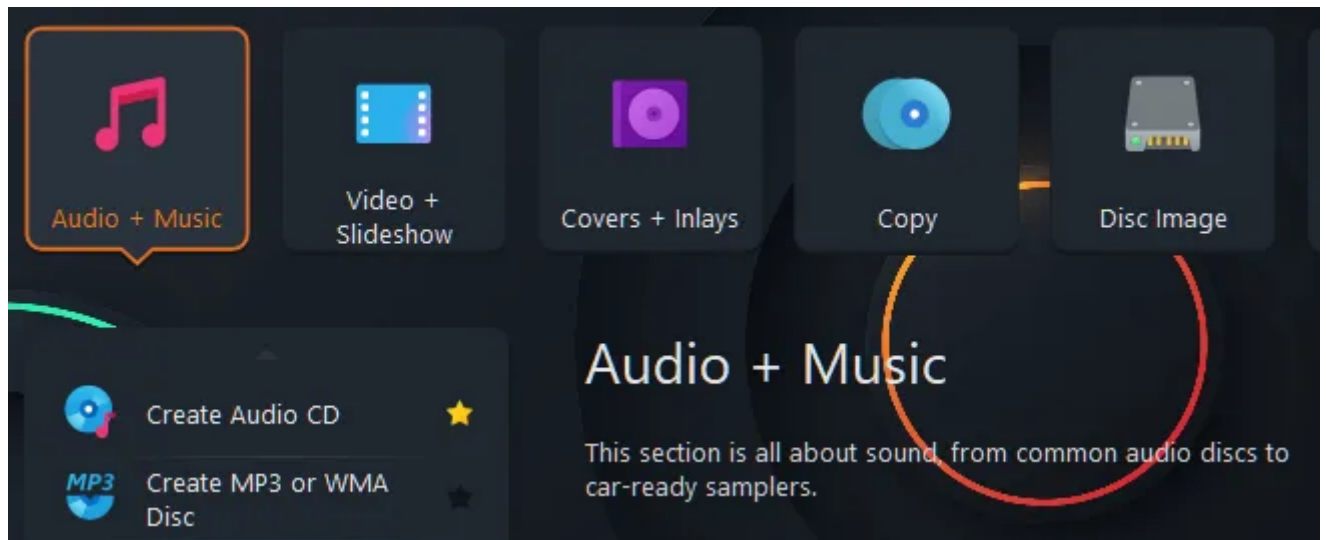

Click a tile to expand its features. The currently selected tile always moves to the left of the screen.

Hover your mouse pointer over a feature to display a brief description and click to navigate to the associated program section.

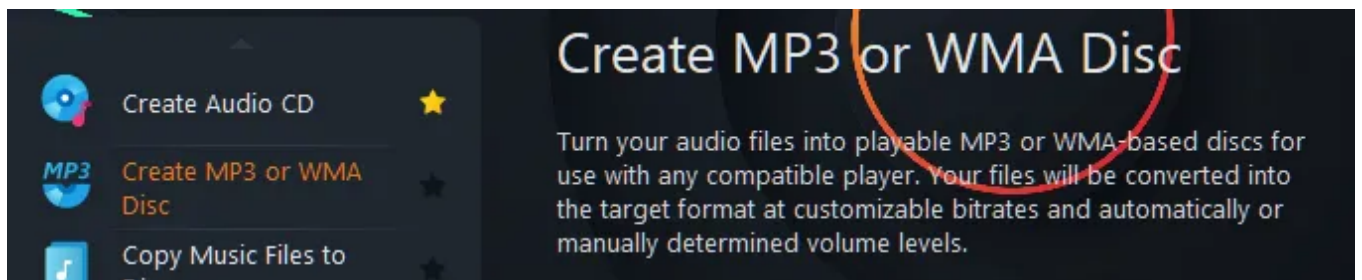

Use the arrow buttons to browse between the tiles. The leftmost tile is always auto-selected.

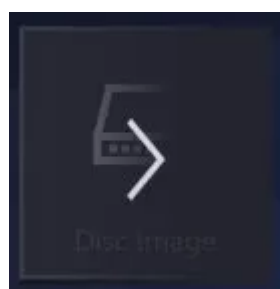

Favorites

The program automatically lists your most frequently used features under "Favorites".



Click the star icon behind a feature to include it under "Favorites".

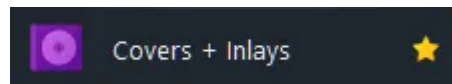

To remove a feature from "Favorites", click the star icon again.

Menu-based mode

This mode displays modules and features as classic menus. Simply hover your mouse pointer over an entry, to display its subentries.

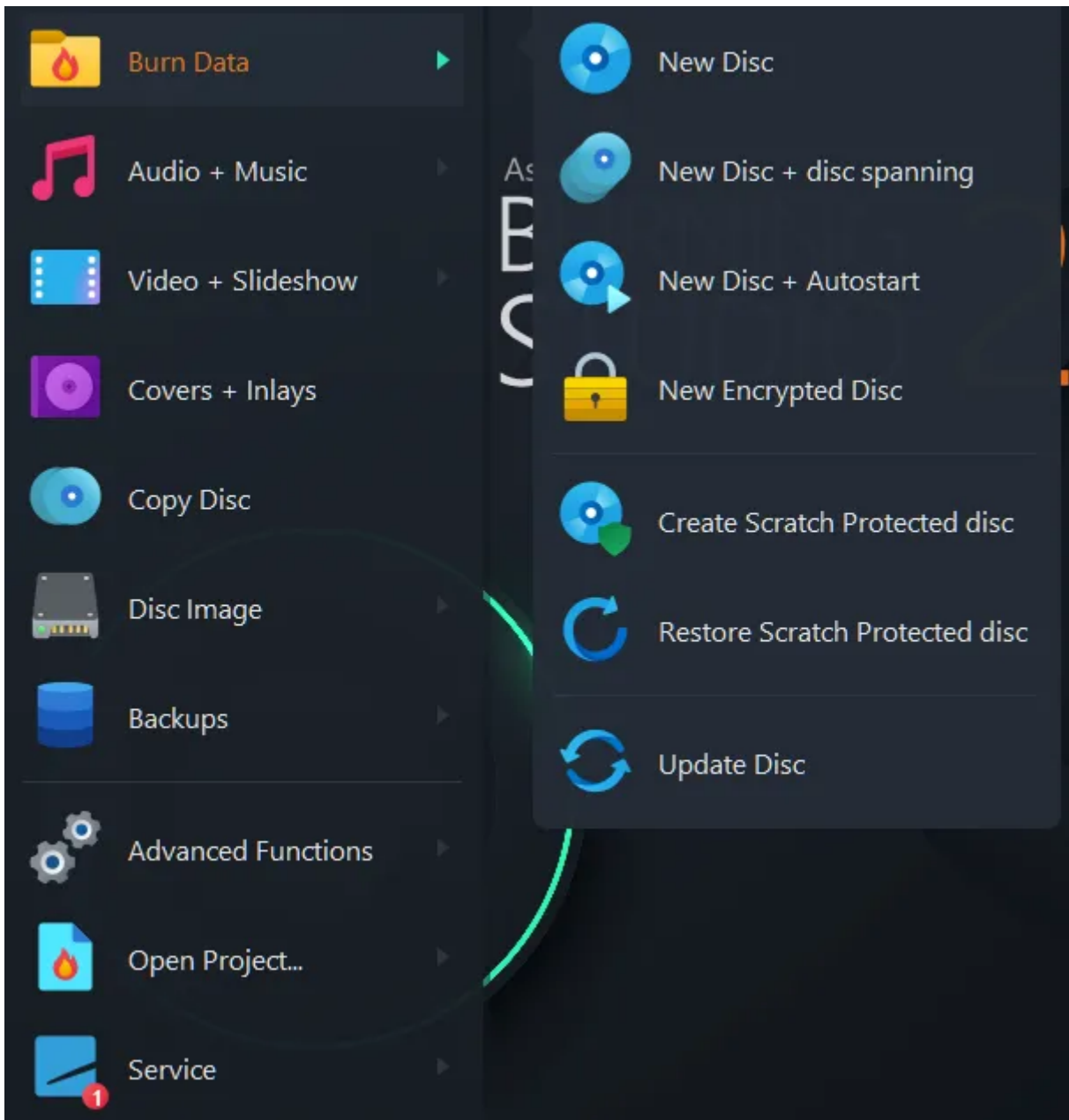

Quickstart shortcuts

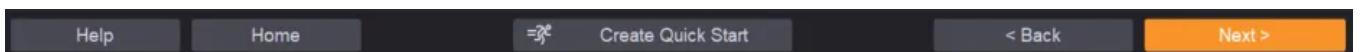

You can create desktop shortcuts to jump directly to the associated section in Burning Studio via double clicking, skipping the start page. Simply use the "Create Quick Start" button.

2. Basics

Breadcrumb bar

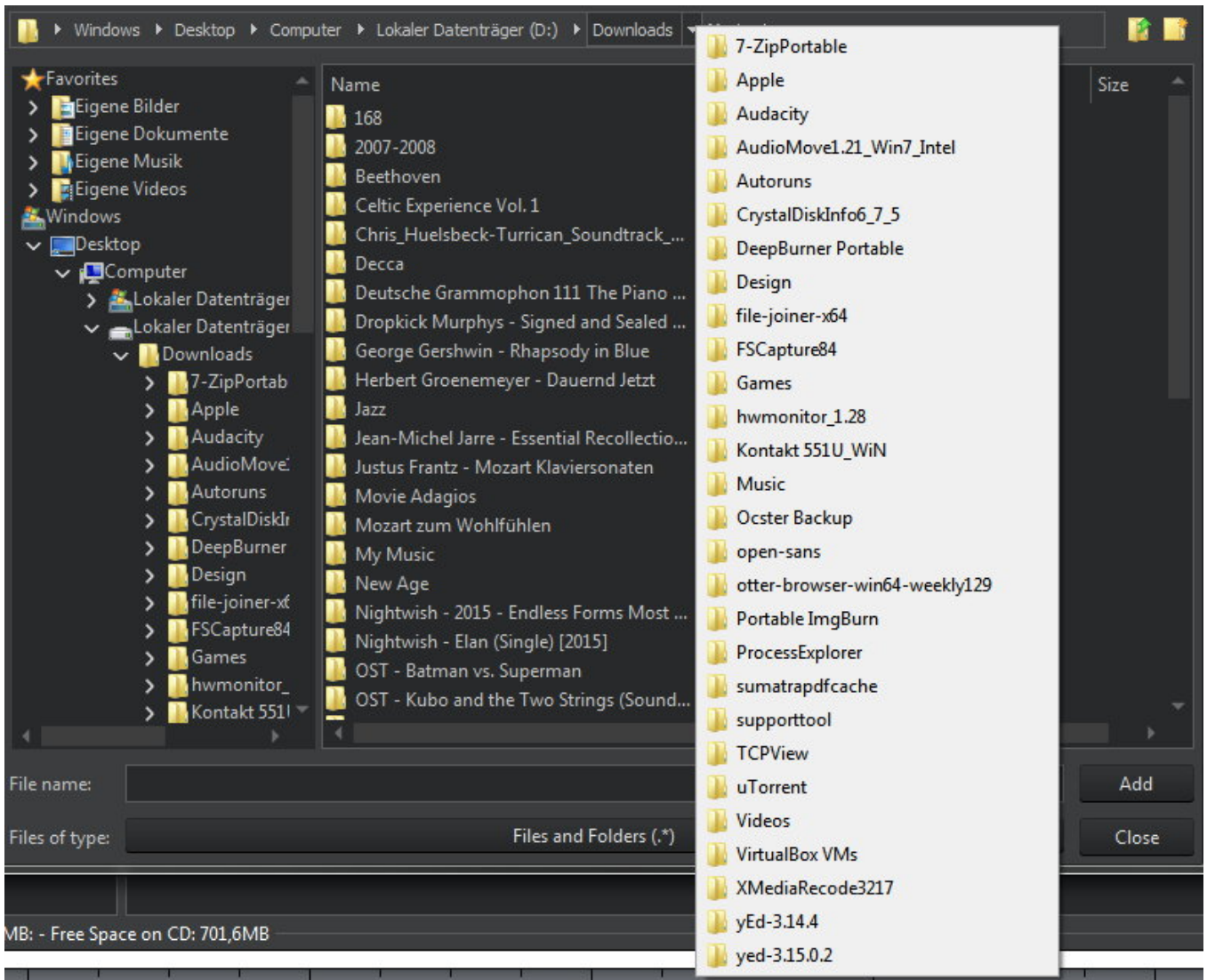

Many file selection dialogs throughout Ashampoo Burning Studio 25 offer a breadcrumb bar that helps you keep track of your files as well as allowing you to navigate quickly between folders. Click the arrow behind a folder to display its contents as a popup menu and select an entry to navigate to that folder.

Project settings

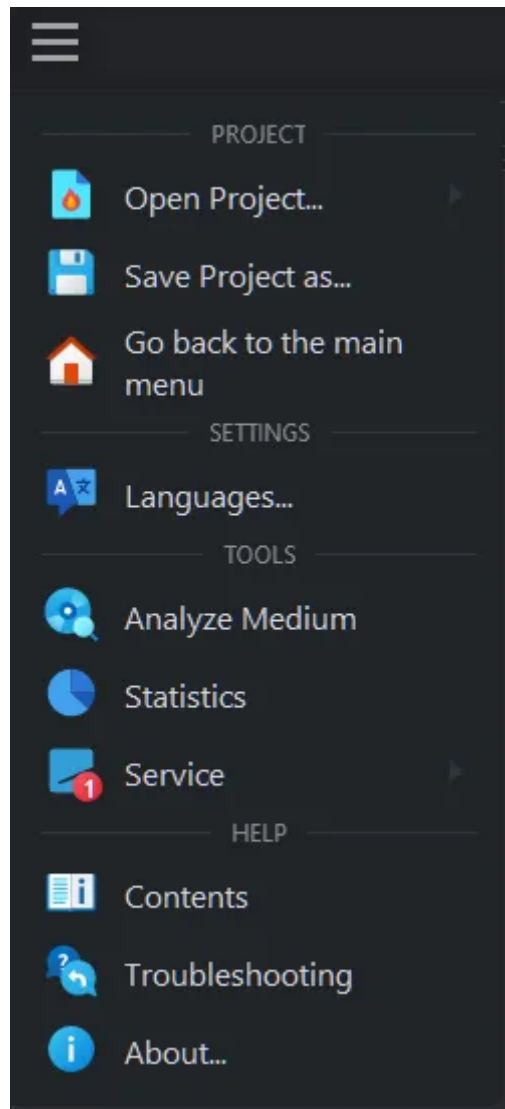

Use the top left button to save your current project settings or load a saved project. You may also change the program language or appearance here.

2.1 Adding files

Adding files is mainly achieved through the following dialog.

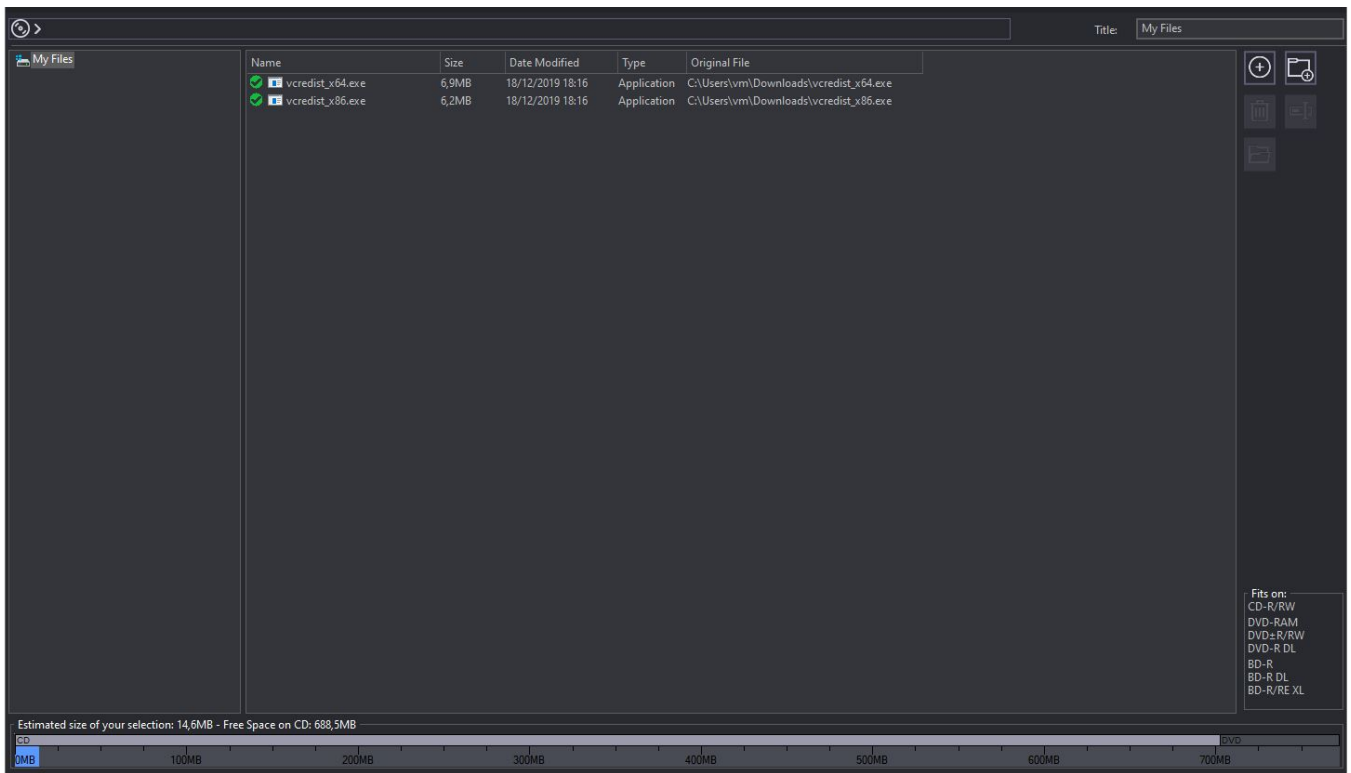

The top navigation bar helps you navigate between existing or newly added folders. Folder structures are shown in the left area, folder contents are displayed in the center. The bar display at the bottom visualizes the current space requirements of your selection. This helps you quickly determine whether your data will fit on a CD for example.

Buttons

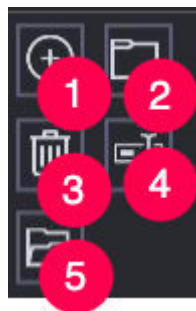

- 1. Add** Allows you to add files and folders. New files will always be added to the currently open folder. In the example above, new files would be added to the "Ashampoo" folder. Alternatively, you may also drag files and folders from Windows Explorer into the window to add them to the project.
- 2. New Folder** Creates a new folder.
- 3. Remove** Removes the selected elements from the project.
- 4. Rename** Renames files and folders.

5. Open Opens the selected file in the Windows default application.

Context menu

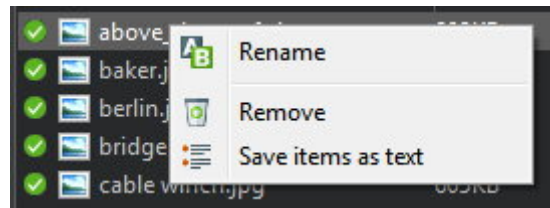

Right-click a file/folder to bring up the context menu.

Rename Renames files and folders within the project.

Remove Removes the selected elements from the project.

Save items as text Creates a text file that contains all file/folder entries.

2.2 Selecting files

With the exception of the backup feature, file selection is either done through the integrated file selection dialog or the Windows default file selection dialog.

Burning Studio file selection dialog

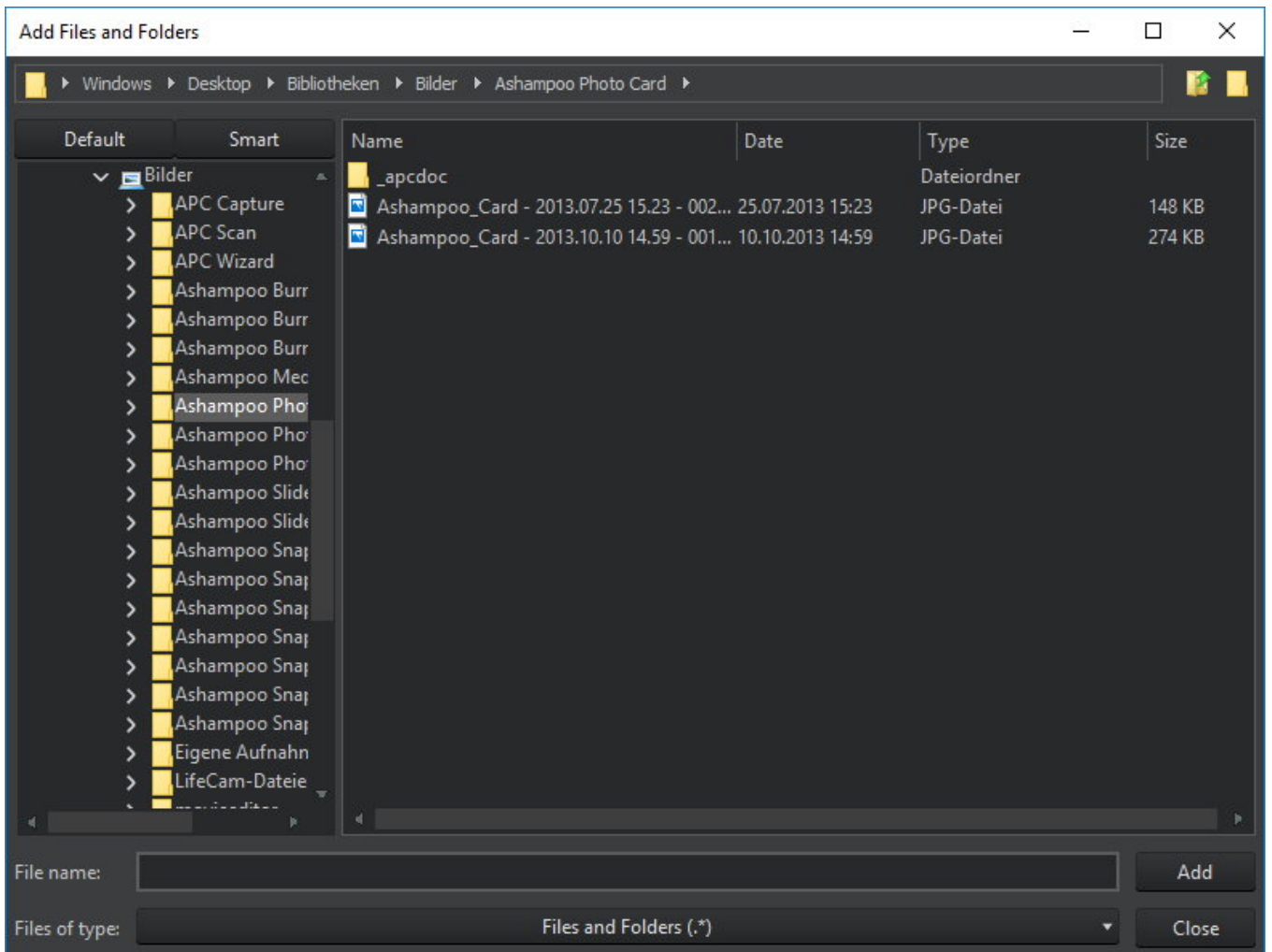

The dialog is structured like the classic Windows dialog with a navigation bar and buttons for "Go back" and "Create folder" at the top, a folder structure view that allows you to click the plus/minus symbols to expand/collapse folders and a folder contents view in the center. Folder contents are displayed as a table view with details such as file sizes. Click a column to sort files in ascending/descending order. "File Name:" and "Tile of type:" behave like their counterparts in the Windows dialog.

Classic Windows file selection dialog

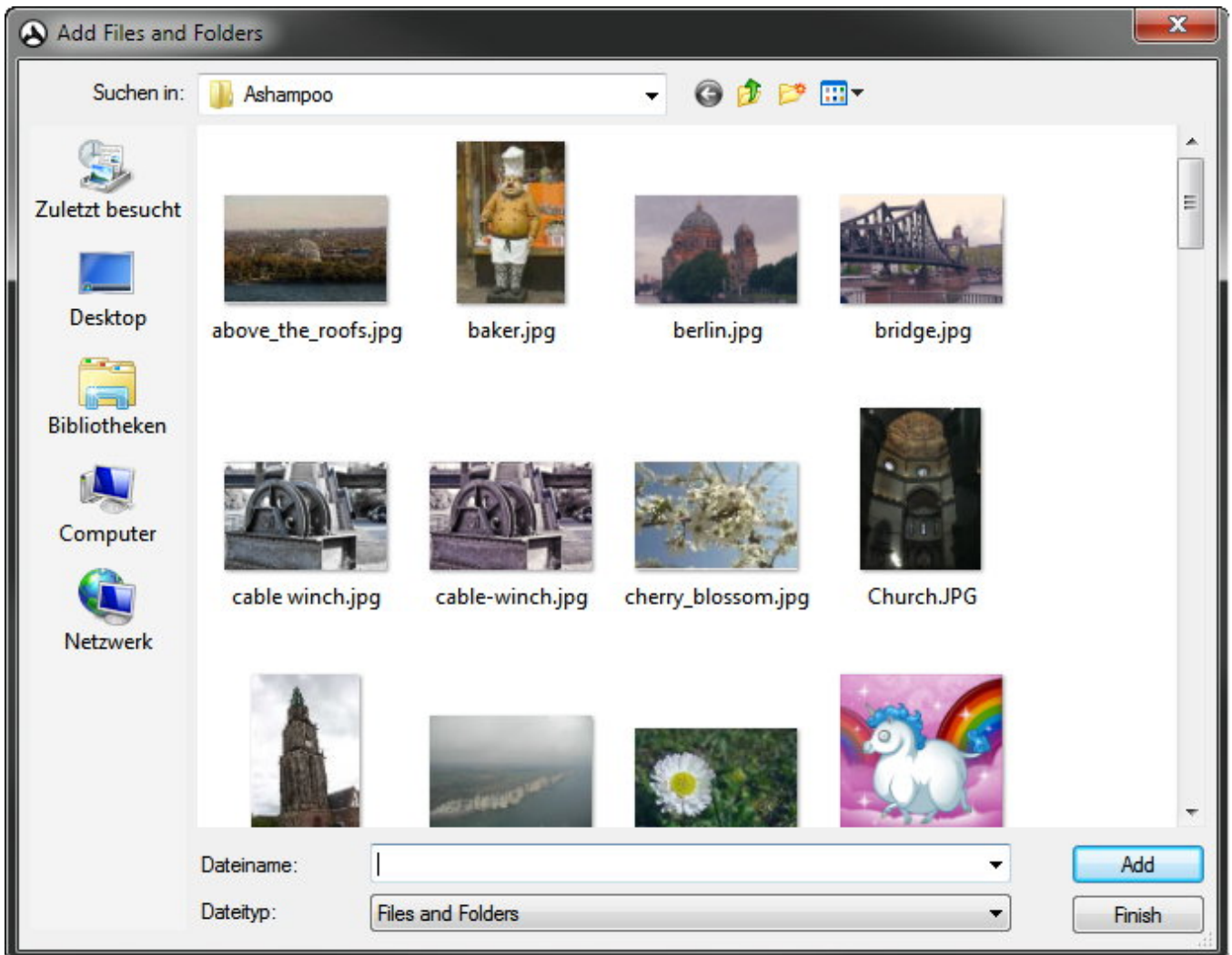

If you have this setting enabled, file selections will be done through the Windows default file selection dialog.

Fast switching between data sources

If your project needs files from multiple different external sources, e.g. when your creating a new audio CD from existing music discs, you can leave the file chooser dialog open. The program automatically detects the switch to a new source disc and updates the file chooser accordingly.

2.3 Selecting a disc recorder

Use the dropdown menu to select your disc recorder or enable "Writing a disc image file instead of burning a disc" to create a disc image instead.

Burning settings

Verify	Enable this setting to have the program check the finished disc for errors.
Finalize	If you're certain you won't be adding any files to the disc at a later time, you may enable this setting to have the disc finalized. By default, this setting is disabled meaning that you can add additional files to the disc at a later time (multisession).
Disc at once	In this mode, all data will be burned to the disc in one go with the disc being finalized thereafter. You may need to enable this setting for audio discs that otherwise won't play in your older CD player.
Cache data	Enable this setting to avoid errors on slower PCs and have all data buffered on your hard disk before burning commences.
Shut down	Enable this option to have the computer shut down once burning is complete.
Sound after burning	If enabled, the program will play a sound once burning is complete.
Speed	Select your desired speed here. You may need to lower the speed in case write errors occur.
Number of Copies	Set the number of copies here. The original disc also counts as 1 copy.

2.4 Disc recording status

During recording, progress as well as status and error messages will be displayed in a separate dialog.

Once the disc is complete, additional steps will be available through the quickstart pane.

2.5 Selecting a drive

Use the drop-down menu to select the drive that contains the disc or click "Open Tray" to insert a new disc.

2.6 Acquiring images

This feature allows you to insert images, e.g. to use them with disc covers.

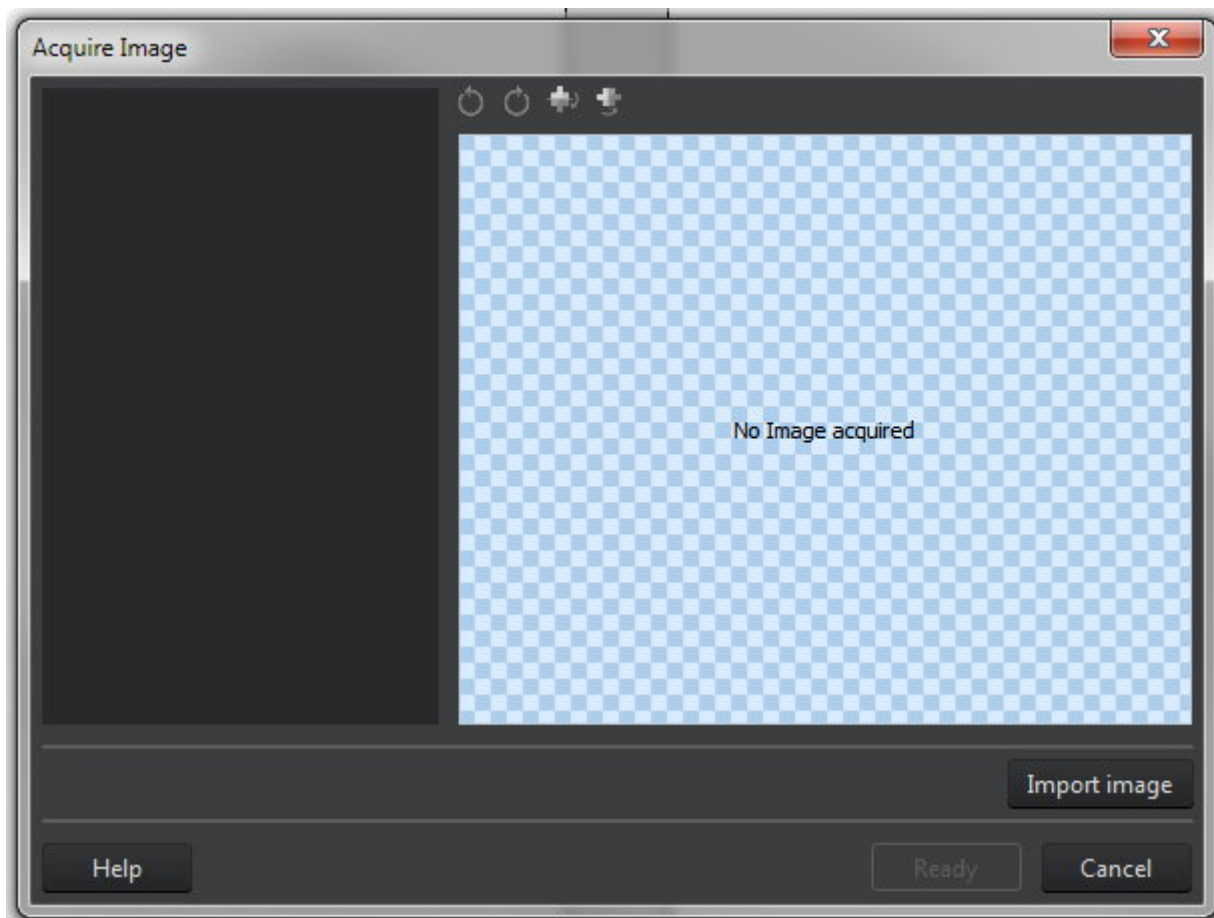

The toolbar allows you to rotate or mirror inserted images.

Import image

- | | |
|-------------------------------|---|
| From internet | Allows you to specify an Internet address for an image source. |
| From file | Loads an image file from a local drive. |
| From scanner or camera | Uses the TWAIN interface to acquire an image through a connected scanner or digital camera using the software that came with the affected device. |

Select source Allows you to select the TWAIN device.

From cover search Uses the cover search feature to retrieve images from the Internet based on search terms. More on that here.

2.6.1 From Internet

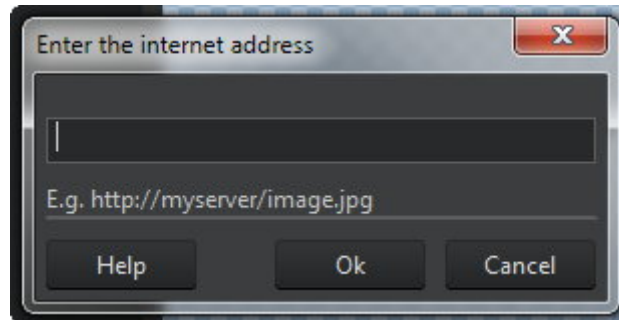

Enter the URL for the image resource to import.

2.6.2 From cover search (Internet search)

This search uses the search term with common online search engines (Google, Amazon, etc.) and displays the results in your default web browser. You can then drag and drop to add found images to your project.

1

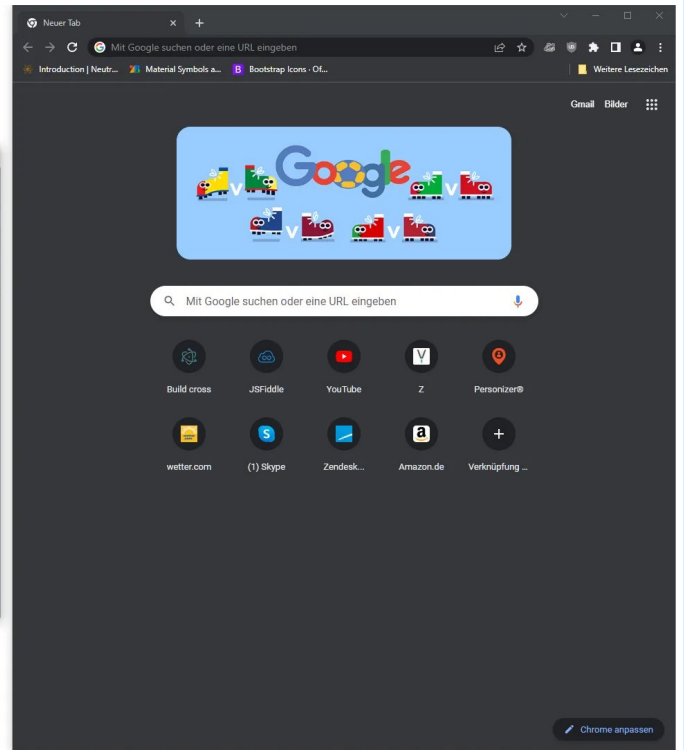
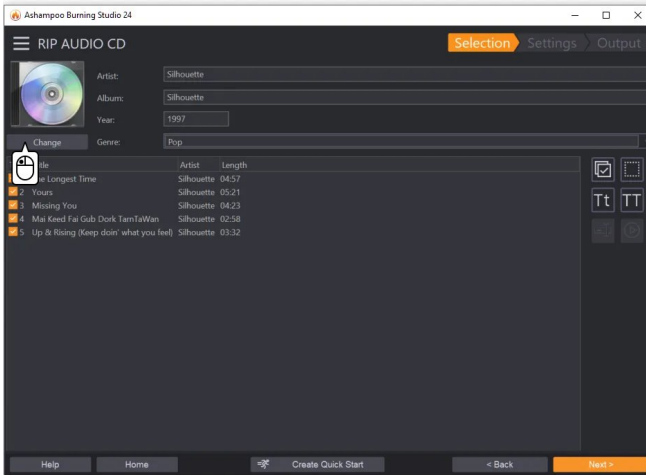

2

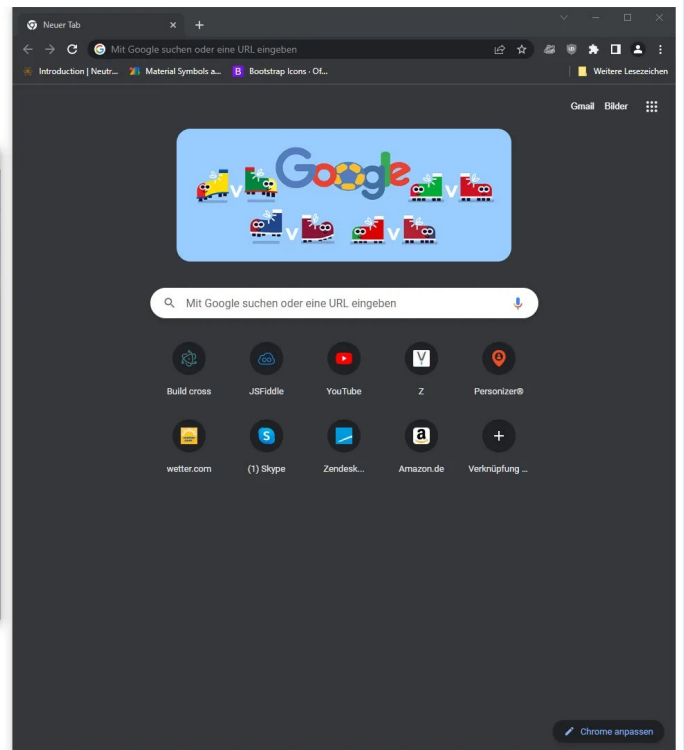
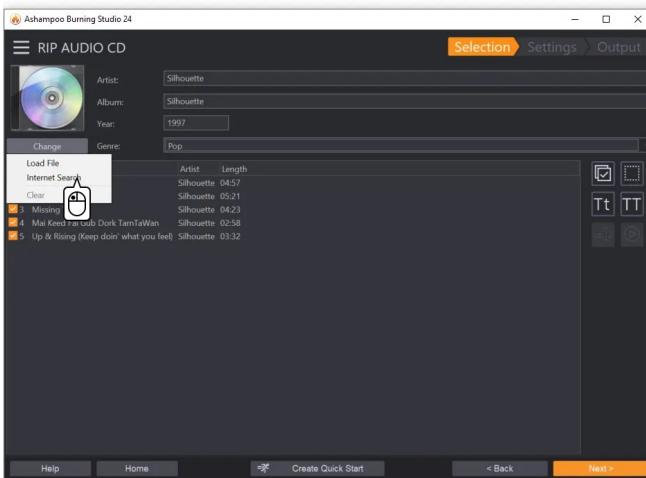

3

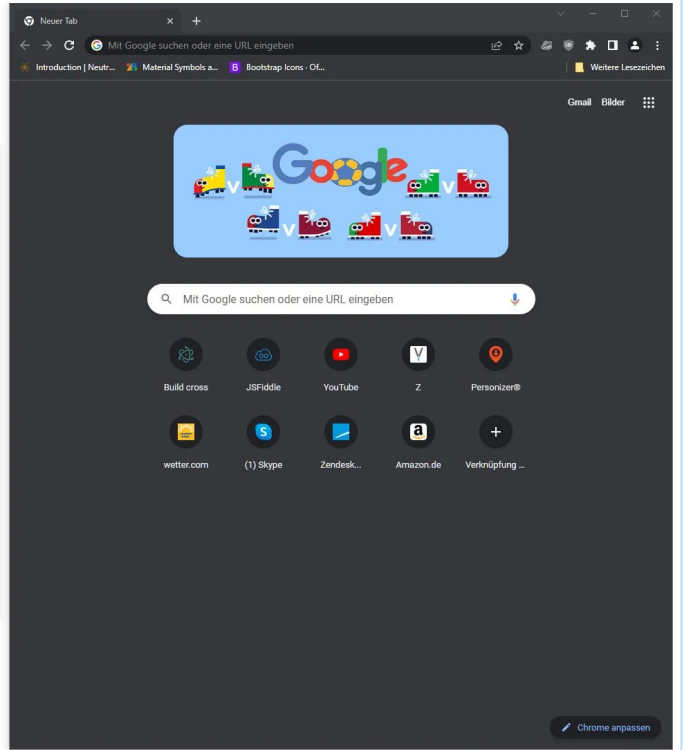
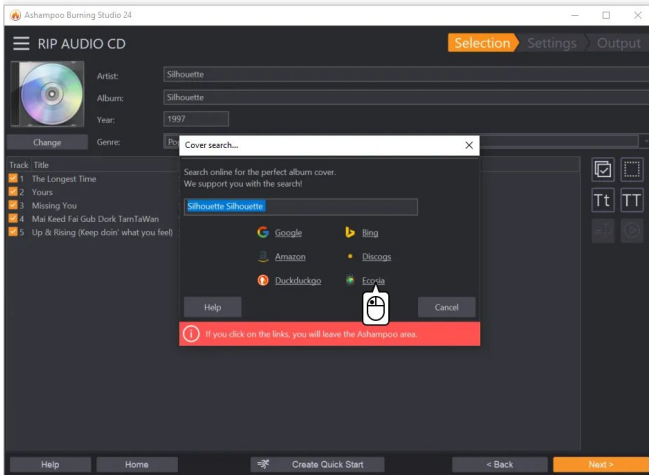

4

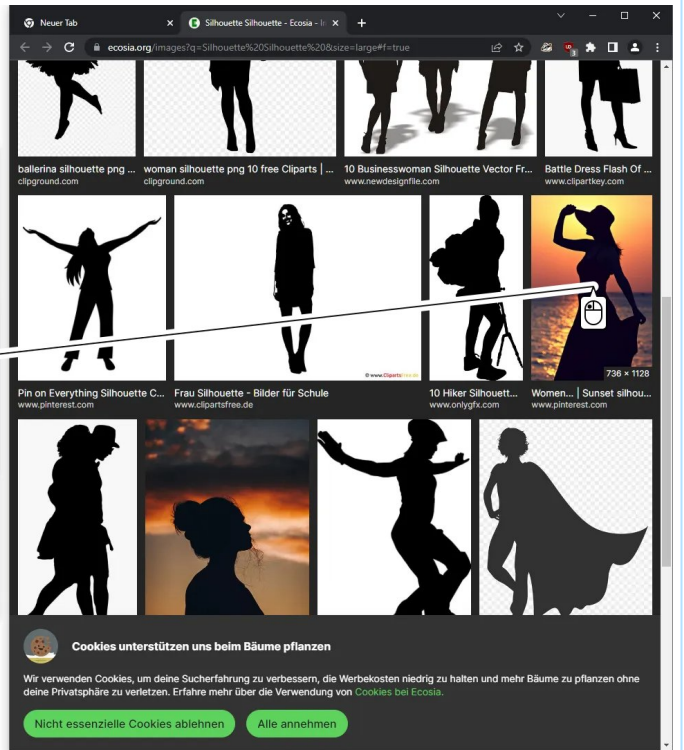
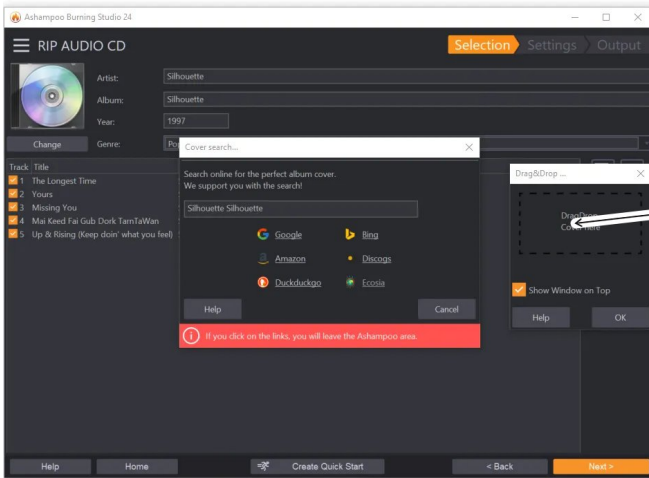

5

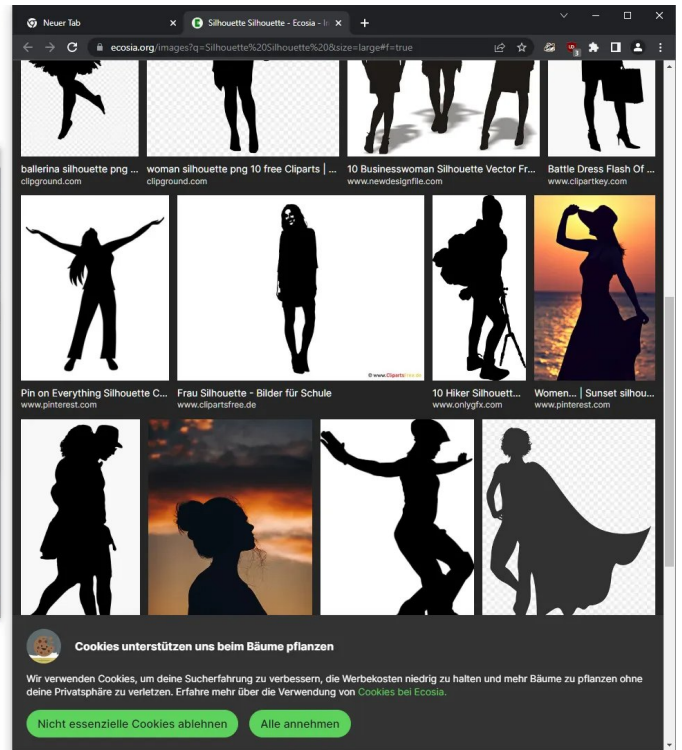
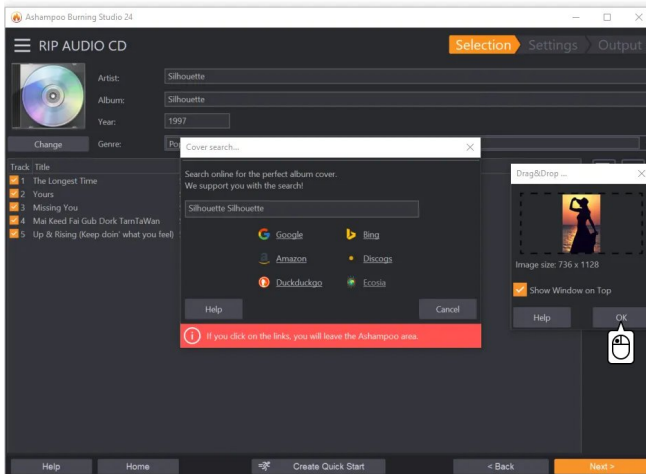

6

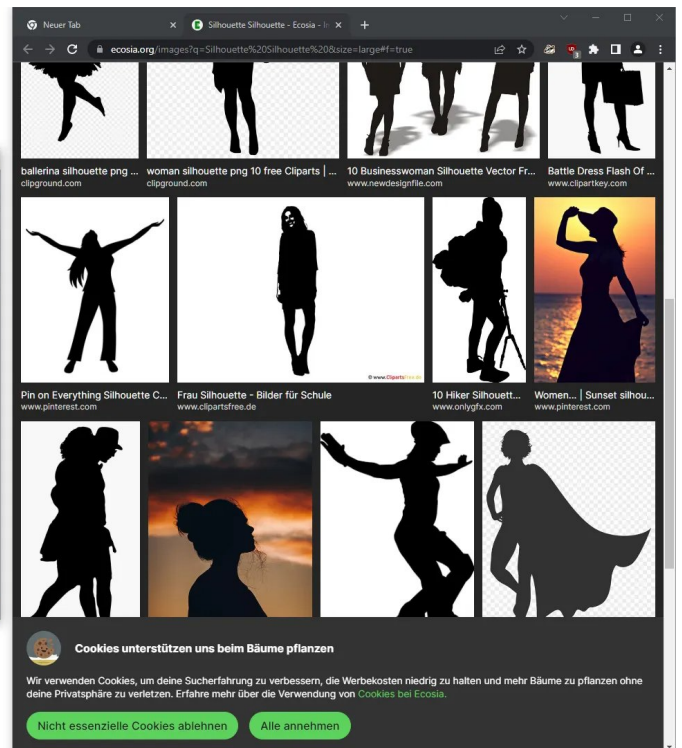
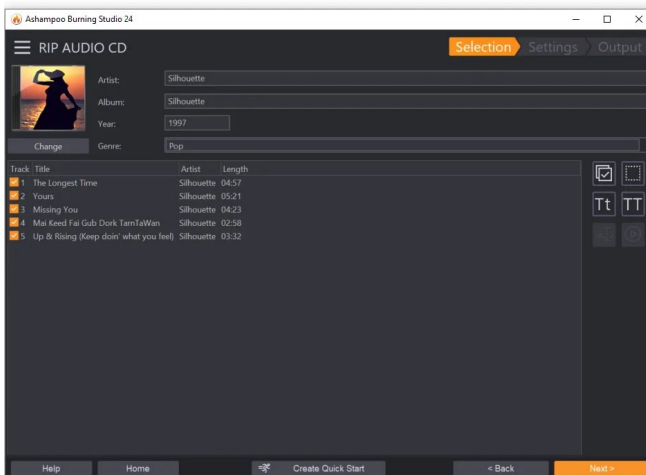

2.7 Editing text

Text editing is done through a separate editor throughout the application.

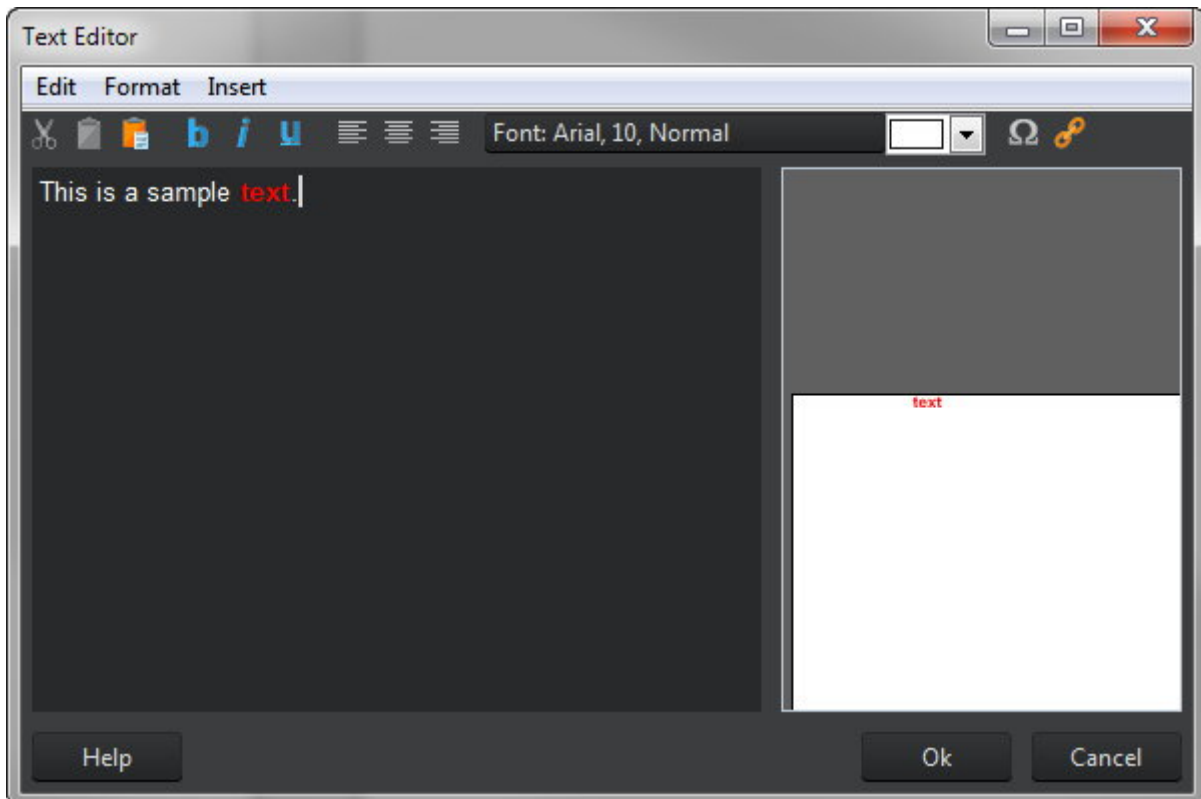

Toolbar

Cut	Cuts the current selection and copies it to the system clipboard.
Copy	Copies the current selection to the system clipboard.
Paste	Pastes the text from the clipboard at the current cursor location.
Bold	Reformats the selected text with bold characters.
Italic	Reformats the selected text with italic characters.
Underline	Reformats the selected text with underline characters.
Align left	Aligns the selected text left.
Center	Centers the selected text.
Align right	Aligns the selected text right.
Font	Allows you to apply a different font and formatting style.

Color Enables you to select a different font color.

Insert symbol Inserts special characters.

Insert URL Inserts an Internet link.

Menus

Edit Provides undo/redo as well as cut/copy/paste functions.

Format Allows you to align text and modify line spacing.

Insert Inserts special characters or Internet links.

2.8 Editing shapes

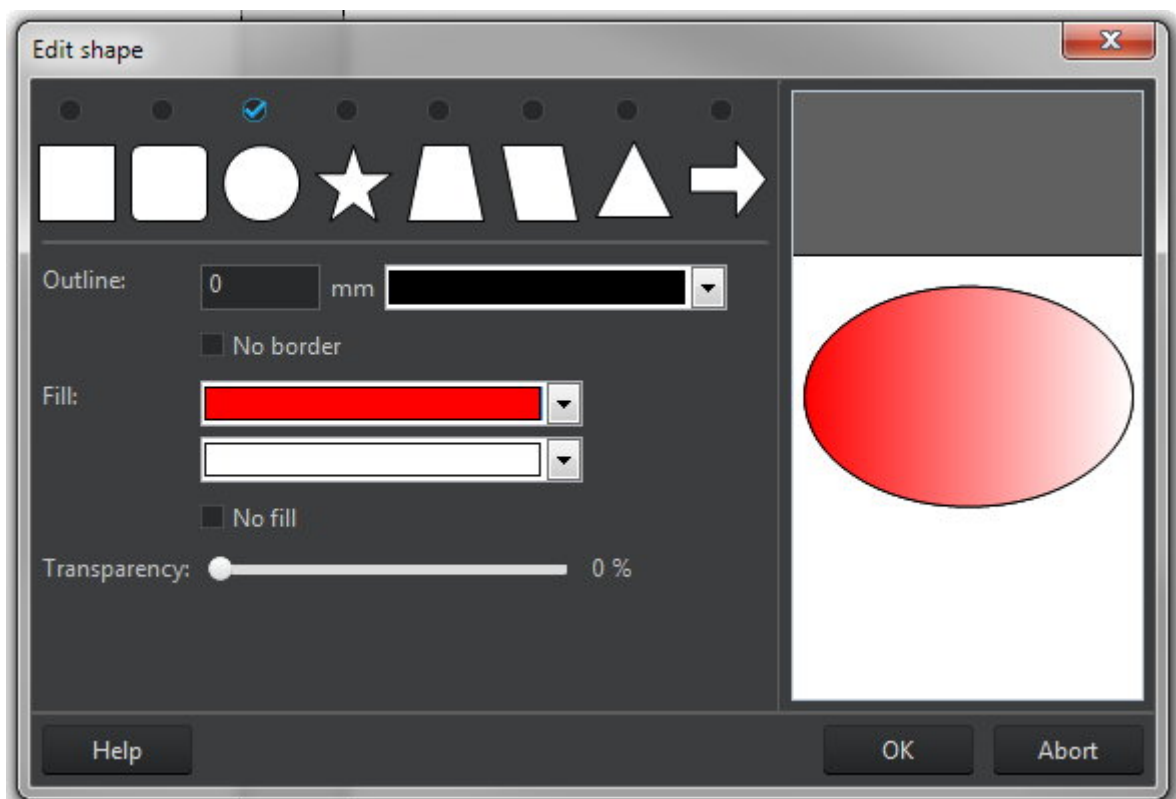

First, select a shape type. Then, use "Pen" to specify the border color and "Brush" to fill the shape with either a single color or two colors as a gradient. Use the transparency slider to adjust the opacity of the shape.

2.9 Editing tables

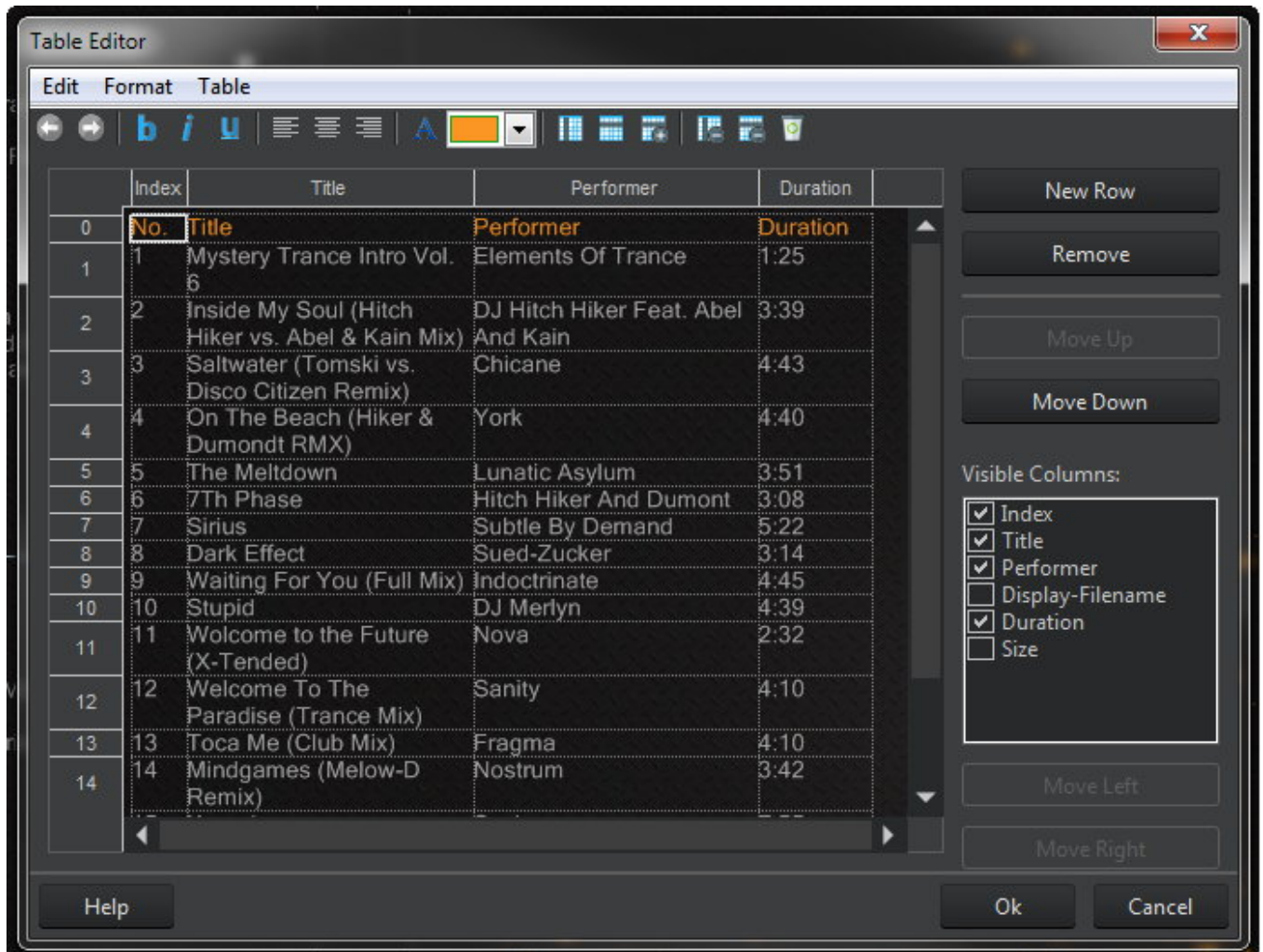

Double-click a table cell to edit it using the text editor. Click the line number to select the entire row or the column number to select the entire column. To adjust column widths, move the mouse to the left or right edge of the affected column label and drag to modify.

Toolbar

- Undo** Undoes the last action.
- Redo** Redoes the last undone action.
- Bold** Reformats the selected text with bold characters.
- Italic** Reformats the selected text with italic characters.

Underline	Reformats the selected text with underline characters.
Align left	Aligns the selected text left.
Center	Centers the selected text.
Align right	Aligns the selected text right.
Font	Allows you to apply a different font and formatting style.
Color	Enables you to select a different font color.
Insert column	Inserts a column behind the selected cell.
Insert row above	Inserts a row above the current row.
Insert row below	Inserts a row below the current row.
Delete column	Deletes the column associated with the currently selected cell.
Delete row	Deletes the current row.
Empty row	Empties the current row.

Buttons

New row	Inserts a new row below the current row.
Remove	Deletes the current row.
Move Up	Moves the current row up by one row.
Move Down	Moves the current row down by one row.
Visible Columns	Allows you to enable/disable single columns.
Move Left	Moves the selected column left by one column.
Move Right	Moves the selected column right by one column.

3. Burn Data

3.1 New Disc

1. [Add the files and folders to be burned.](#)
2. [Select a disc recorder and adjust the burning settings.](#)
3. Start burning. The current recording status will be displayed visually.

3.2 New Disc + Disc Spanning

Disc Spanning allows you to backup huge amounts of data across multiple discs with ease. The program will determine the number of required discs for you and burn them sequentially. Apart from that, the procedure is identical to burning a regular data disc. The program will automatically prompt you to insert the next disc once a disc is finished.

3.3 New Disc + Autostart

Aside from data, your discs may also include a sophisticated menu or autostart behavior that will launch a particular file, once the disc is inserted.

1. [Add files and folders to be burned.](#)
2. Select your desired autostart behavior: [Interactive Menu](#) or [Autostart](#)[^]
3. Select a disc recorder.
4. Start burning. The current recording status will be displayed visually.

3.3.1 Interactive Menu

Format

Stand-alone (Default)

Browser-based

Product Title

Title:

Background Music

File:

Loop the music

This will play in the background for as long as the menu is open (30 seconds max. due to file size).

Icon

This icon will be used in Windows Explorer for the disc or drive.

First, select whether the menu will be a standalone application or be run in a web browser and enter a title. You may additionally select a background music and modify the icon that will be displayed in the task bar.

3.3.1.1 Setting the splash screen

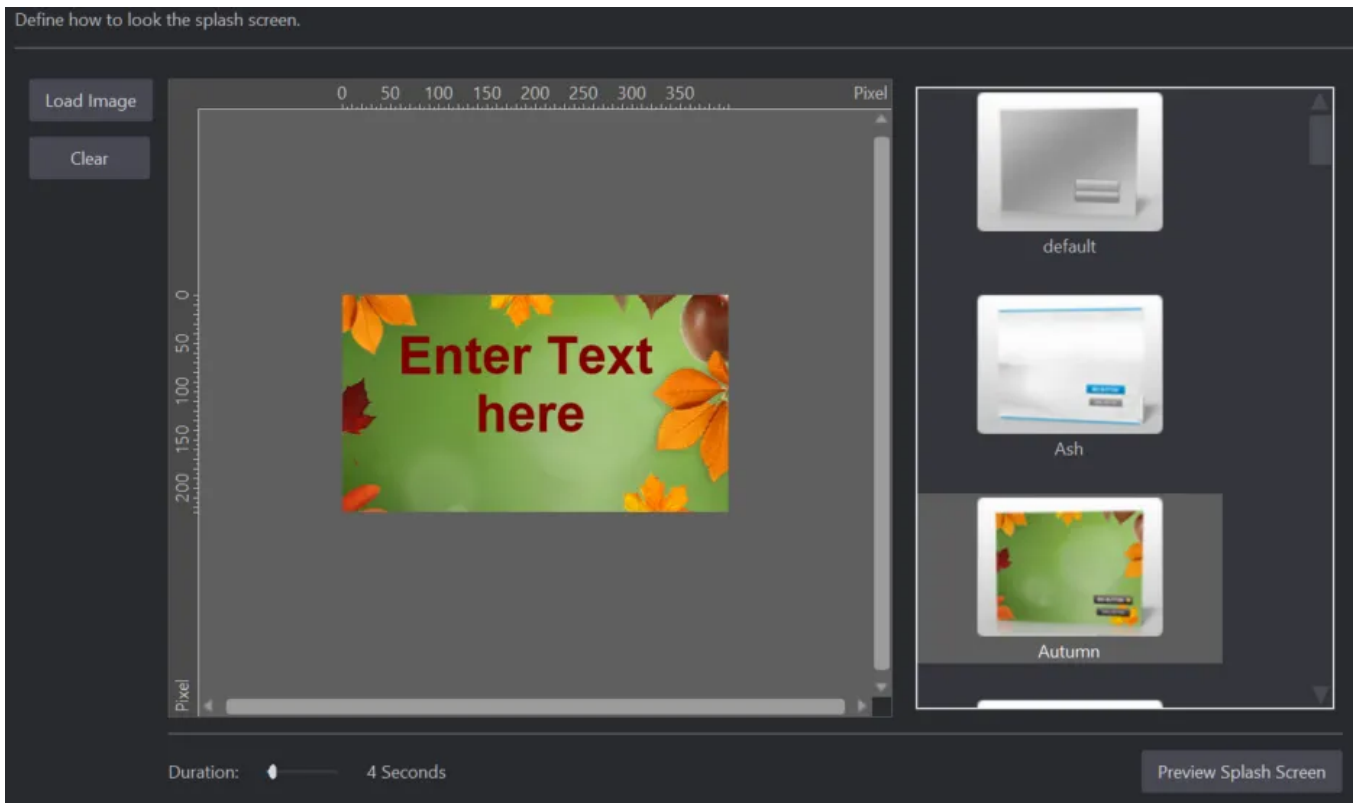

Either select a design from the left or use "Load Image" to set a background image. If you select a design, you will also be able to edit the greeting text. Use the slider to adjust the display duration for the splash screen.

3.3.1.2 Editing the design

The menu designer helps you create individual disc menus.



The example above is using the "Autumn" theme with a "2x2 with Image" layout. Double-click a theme/layout to adjust your settings later.

Toolbar

Undo	Undoes the last operation.
Redo	Redoes the last undone operation.
Cut	Cuts the current object and copies it to the system clipboard.
Copy	Copies the current object to the system clipboard.
Paste	Pastes the currently copied object into the menu.
Duplicate	Creates a copy of the selected object.
Delete	Deletes the selected object.
Send to front	Sends the selected object to the front.
Send to back	Sends the selected object to the back.
Rotate left	Rotates the selected object 90° left.

Rotate right	Rotates the selected object 90° right.
Mirror vertically	Mirrors the selected object vertically.
Mirror horizontally	Mirrors the selected object horizontally.
Acquire image	Allows you to insert images from external source. More on that here .
Preview	Displays a fully functional menu preview.

Working with objects

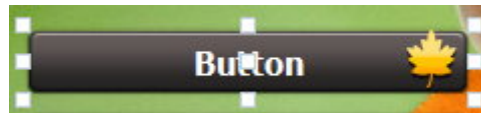

Click an existing object to select it and drag the surrounding markers to adjust its size. Drag the center marker to adjust its position. Hold down Alt or Ctrl while dragging to align an object either with existing objects or the center point of your menu.

Double-click an object, e.g. a button, to view its [properties](#).

New Button	Creates a new button.
Background	Allows you to select a an image file as background image.
New Image	Creates an image object.
New Text	Creates a text object using the text editor . Adjust the size of the object to modify the angle for circular text objects.
New Shape	Creates a shape. More on that here .

Files / Buttons tabs

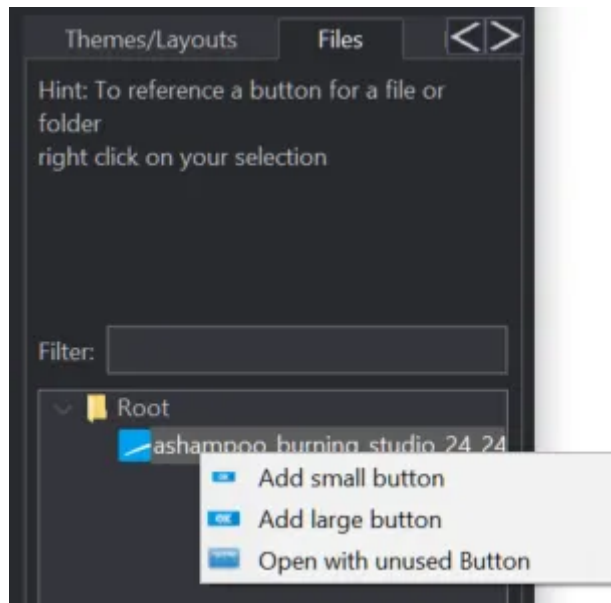

"Files" contains a list of all files included in the current project. Right click an entry to create a button that is linked to that file.

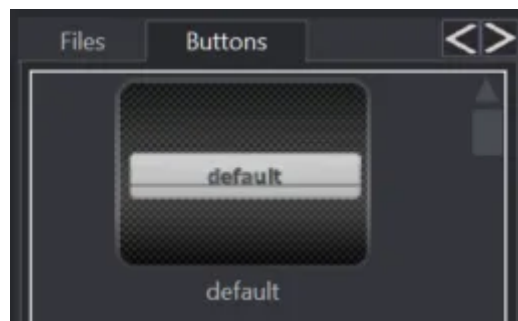

"Buttons" allows you to apply different designs to selected button objects or create new objects by double-clicking.

Editing buttons

Edit Button ×

Define the name and action for the selected button

Name:

Hint:

The following hint is displayed while a user moves the mouse over the button

Action

Please define what action should be taken when the button is clicked:

Execute a file

File:

Open a folder

Folder:

Change active page

Page:

Open a website

Website Address:

Send an E-Mail

E-Mail Address:

Quit the program

You may specify different behaviors for each button. First, enter a name and tooltip text. Then, select your desired behavior. Depending on the selected behavior, you may need to specify additional data such as a URL for "Open a website". Use the preview feature from

the toolbar to test your settings.

Editing pages

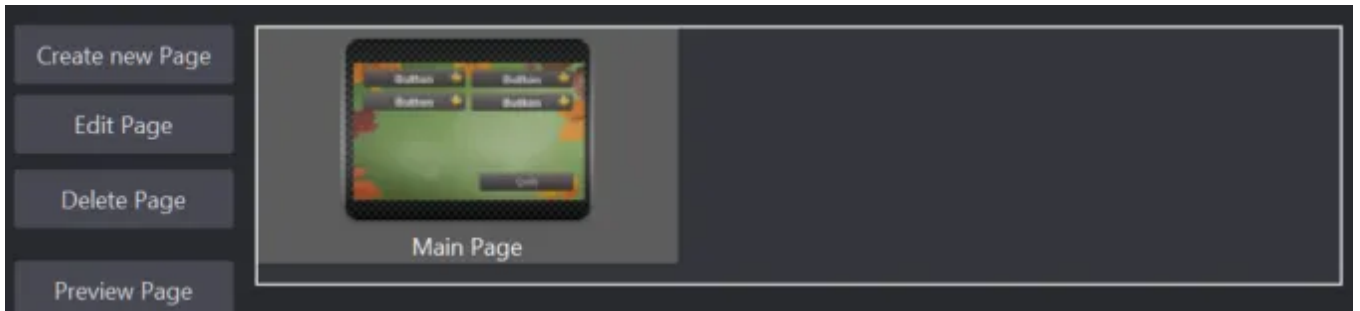

Each page can contain individual button an object combinations. You may provide page navigation by adjusting [button properties](#).

Create new Page Creates a new page. More on that here.

Edit Page Allows you to [rename](#) a page.

Delete Page Deletes the selected page from the menu.

Preview Page Displays a fully functional page preview.

Creating new pages

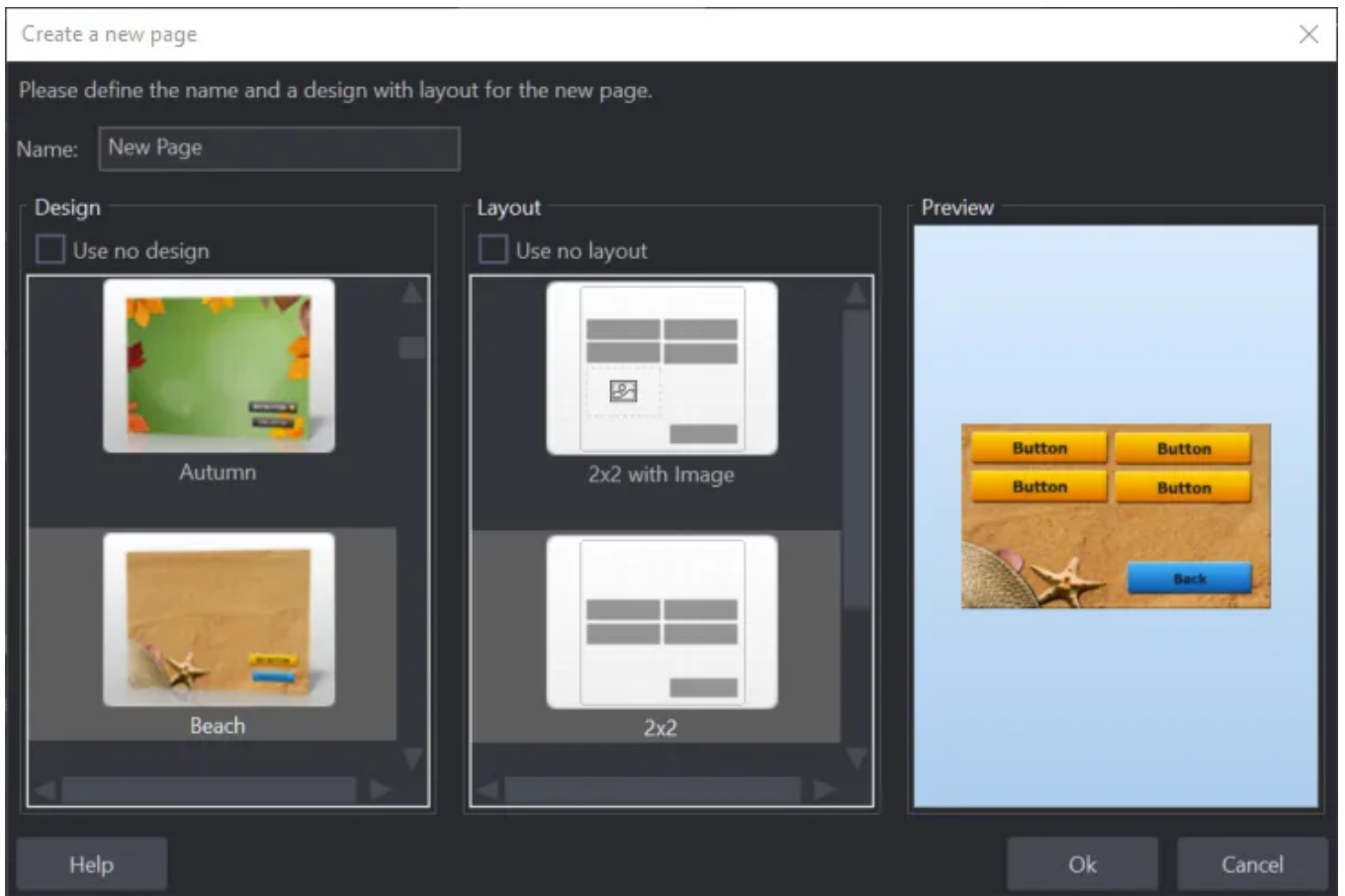

First, input a name for the new page. You may then select an existing design or layout.

Editing pages

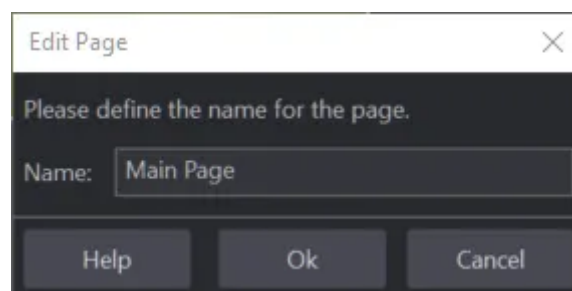

Simply enter the new name and click "Ok".

3.3.2 Autoplay

Select a file to be opened when the disc is later inserted and specify an icon, if required.

3.3.2.1 File selection

Only files that will be included on the disc are selectable.

3.4 New Encrypted Disc

1. [Add the files and folders to be burned.](#)
2. Then, specify the password to be used. You will require the password whenever you try to access your files later.
3. [Select your disc recorder and settings.](#)
4. Start burning. The current [recording status](#) will be displayed visually.

3.5 Create disc with scratch protection

To ensure readability of your data even in the event of significant surface damage, this function creates and burns multiple copies of your data that will be later used instead of the damaged original files. Note that file duplication diminishes the overall storage capacity of your disc.

1. Add the files and folders to be burned.
2. [Select a disc recorder and adjust the burning settings.](#)
3. Start burning. The current [recording status](#) will be displayed visually.

A rescue program will automatically be included in your compilation. The corresponding files are auto-selected and cannot be removed.

Protection Level

This display gives you visual feedback on how many copies will be created depending on your current file selection (more than 32 in this example). The more copies, the higher the chances of data recovery in the event of physical disc damage. Note that the program will always use up the entire available disc space to create as many copies as possible.

Click the disc types to update the status bar for the selected type.

Status bar

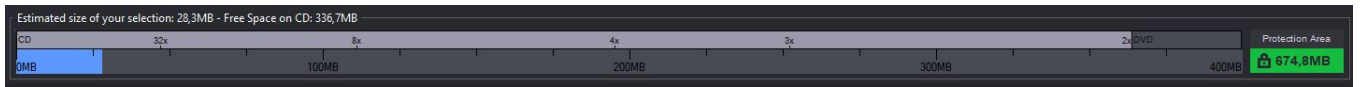

Scratch protection uses up at least 50% of the available disc space. In the above example, a DVD with a capacity of 4.6 GB is used. This means, the user has 2.3 GB of space available for files. 0.6 GB have already been used which means 1.6 GB are still available. "Protection Area" shows how much disc space will be used to create copies.

3.6 Restore disc

Naturally, you can open discs that were burned using scratch protection the same way as any regular disc in Windows Explorer. In the event of disc damage, we recommend you use the rescue tool either through Ashampoo Burning Studio 25 or by double-clicking "_startrescueexplorer.exe" on the affected disc.

Ashampoo Rescue Explorer

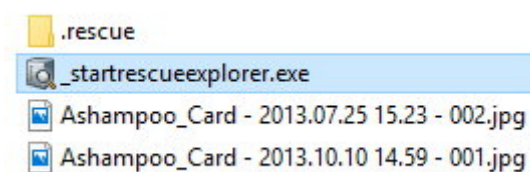

Ashampoo Rescue Explorer can restore your data from scratched discs that were created with the scratch protection feature. To launch the program from the affected disc, simply double-click the "_startrescueexplorer.exe" file.

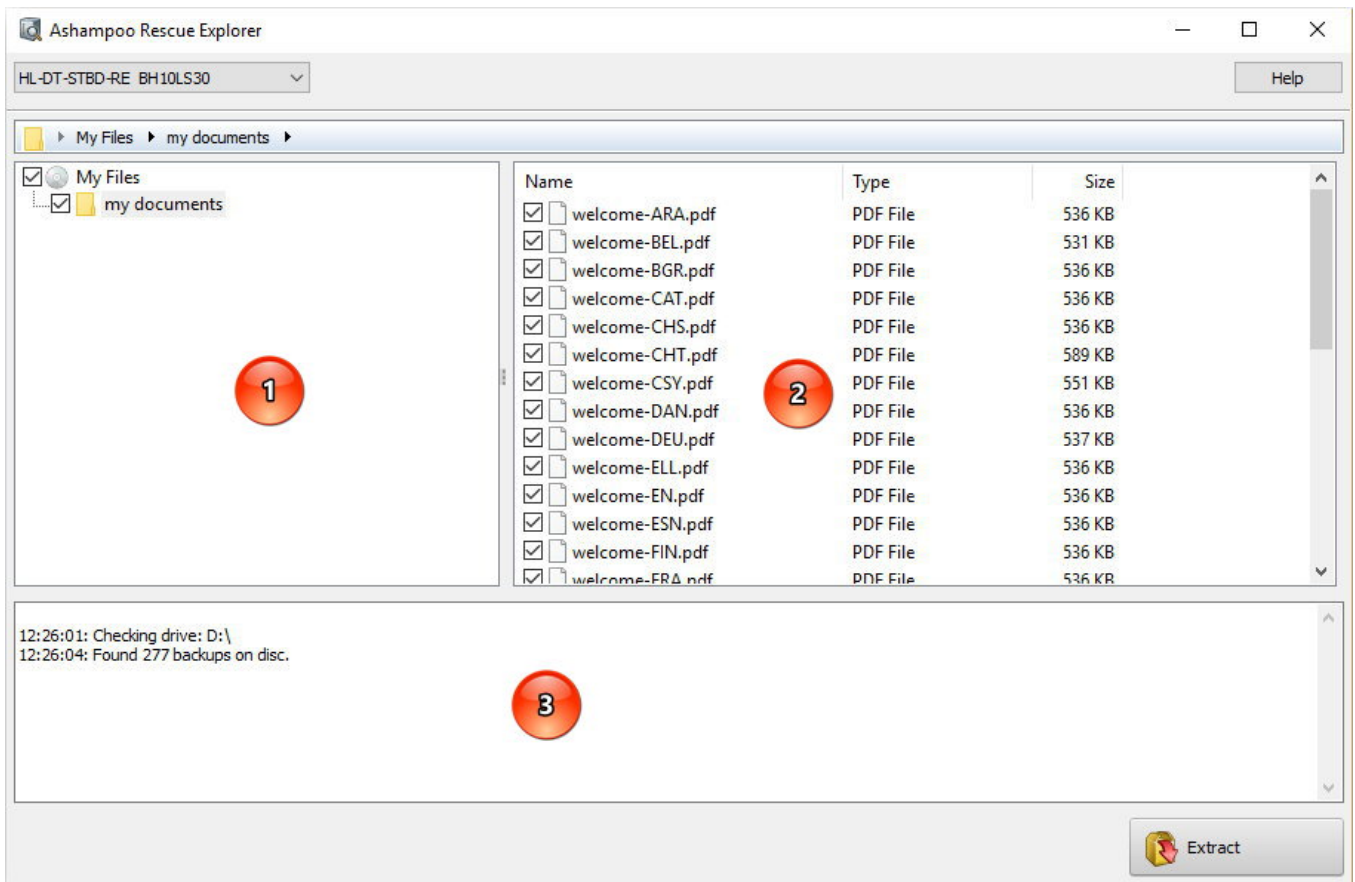

- 1. Directory structure** Folders are presented as a hierarchical tree view. Use the plus/minus buttons to expand/collapse individual folders and the checkboxes to select them including contained subfolders and files.
- 2. Directory content** Files and subfolders for the currently selected folder (1) are shown here. Use the checkboxes to select individual folders/files.
- 3. Status view** Details on the current recovery process are displayed here.

Click "Extract" and select the target folder to begin the recovery process. Details will appear in the status view (3). The program will automatically replace corrupt files with one of the backups (if available).

3.7 Update Disc

Use this feature to add files to existing, not yet finalized discs. Note that, even though you are able to remove existing files through the file selection window, these files will only be marked as deleted for non rewritable discs and will continue to occupy space.

The procedure itself is mostly identical to "New Data Disc" but the order of the steps is slightly different.

4. Audio + Music

4.1 Create Audio CD

Click the plus button to add audio files. Use the arrow up/down buttons to move songs up or down in the playlist and use the trash can button to delete files. Click the two intertwined arrows to randomly rearrange your songs, use the play button to preview your songs and the button with the three sliders to access the [equalizer settings](#) for the selected files.

Use [normalization](#) to adjust the volume levels of your songs and to modify the pauses between songs.

Then, [select your disc recorder](#) and start the burning process.

4.1.1 Equalizer effects

Click a song and then select an effect from the "Equalizer" dropdown menu. Use the bottom player to preview your changes.

4.1.2 Normalization

Normalization adjust the volume levels of several songs around a common level. Use the slider to set the volume level manually or let the application to it automatically for you.

4.1.3 Pauses

By default, the program places a 2s pause in between songs but you can also disable pauses entirely or enter your own duration for each song.

4.2 Create MP3 or WMA Disc

First, select an output format and bitrate/quality. The higher the quality, the fewer files will fit on your disc. Then, add your audio files. Once you've then [selected your disc recorder](#), your files will be converted and the [burning process](#) will commence.

4.2.1 Adding audio files

The [procedure](#) is identical to that of creating a data disc except only audio files can be added this time. Aside from individual files, you can also add files from playlists in the common ".m3u" format.

4.2.2 Conversion status

Progress is displayed visually.

4.3 Copy Music Files to Disc

1. Add the files to be burned.
2. [Select a disc recorder and settings.](#)
3. Start burning. The current [recording status](#) will be displayed visually.

4.4 Rip Audio CD

Ripping turns your music CDs into audio files such as MP3s.

Insert your audio CD. Then, [select your tracks](#) and add information on artist, title etc. Finally, adjust the [settings](#) and begin ripping.

4.4.1 Selecting tracks

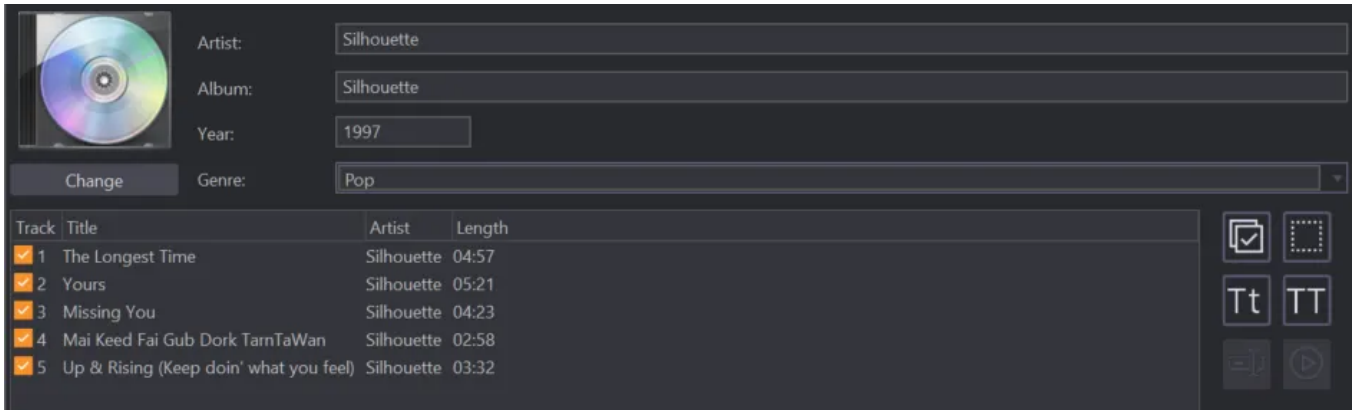

By default, all tracks will be selected followed by an online search for additional information such as artist, title etc.



- Select All** Select all tracks.
- Select None** Clears the selection.
- Capitalize** Capitalizes the first letter of all entries including artist, album and genre.
- Rename** Renames the selected track.
- Play** Plays the selected track with the integrated audio player.

Change cover

Click "Change" to select an image file as cover or perform an [online cover search](#).

4.4.2 Settings

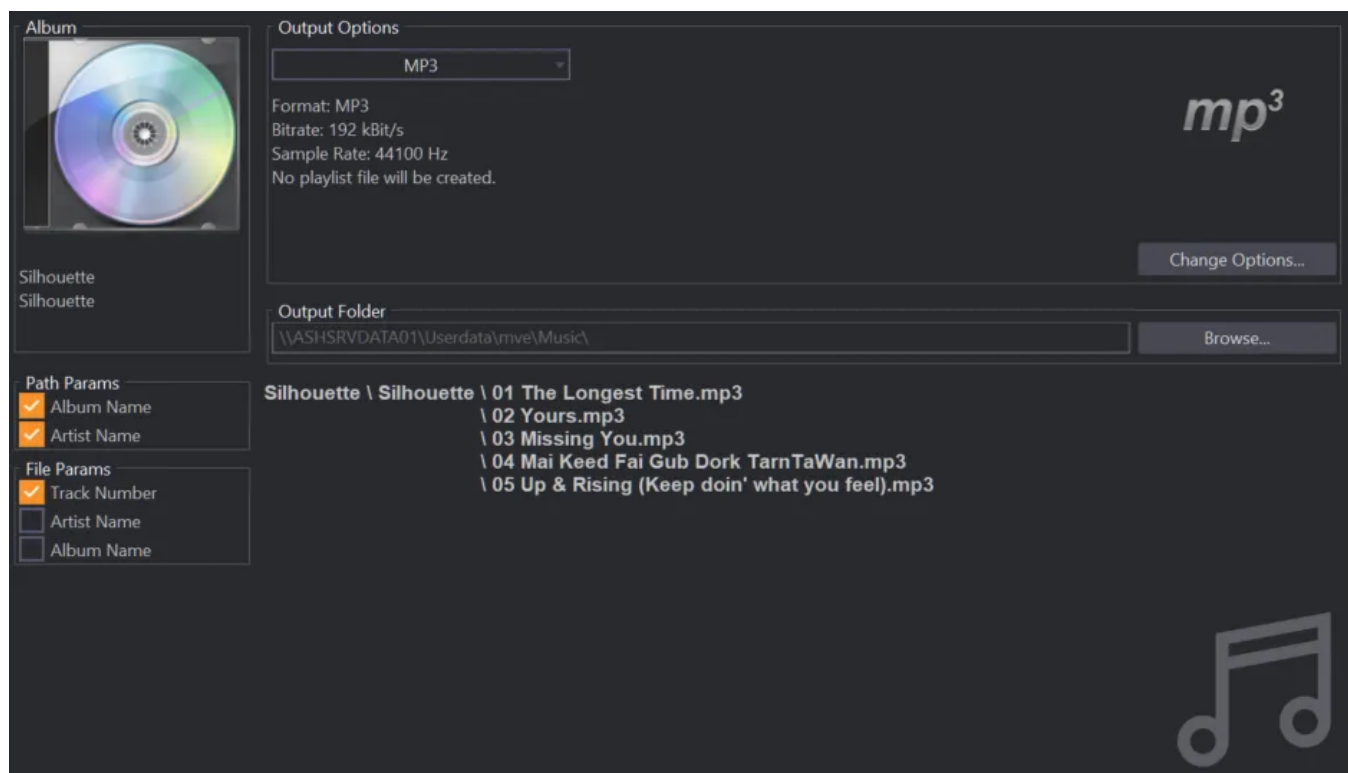

Output Options

Select the output format and quality. You may access quality settings through "Change Options...".

Output Folder

Select the output location for the new files here.

Path / File Params

You may adjust the structure of the file names to your needs. Either select individual path parameters such as album name and artist or enable "Customize" and adjust the structure manually. Use the center preview to check your settings.

Adjusting parameters

For maximum flexibility, you can adjust the naming scheme manually. By default, the backslash character (\) will be used as separator, creating additional subdirectories for each preceding segment. Using "C:\\" as output folder, this will turn "%ARTIST%\%ALBUM%\%TITLE%" into "C:\Queen\Innuendo\Innuendo.mp3".

Use the left checkboxes to toggle individual details via mouse click.

Ashampoo Burning Studio 24

Selection Settings Output

RIP AUDIO CD

Album



Silhouette
Silhouette

Output Options

MP3

Format: MP3
Bitrate: 192 kBit/s
Sample Rate: 44100 Hz
No playlist file will be created.

Change Options...

Output Folder

\\VASHSRV\DATA01\Userdata\mve\Music\

Browse...

Path Params

- Album Name
- Artist Name
- Track Number
- Artist Name
- Album Name

01 The Longest Time.mp3
02 Yours.mp3
03 Missing You.mp3
04 Mai Keed Fai Gub Dork TarnTaWan.mp3
05 Up & Rising (Keep doin' what you feel).mp3

Customize

%TRACK% %TITLE%

Add Placeholder

Help Home Create Quick Start < Back Rip >

Ashampoo Burning Studio 24

Selection Settings Output

RIP AUDIO CD

Album



Silhouette
Silhouette

Output Options

MP3

Format: MP3
Bitrate: 192 kBit/s
Sample Rate: 44100 Hz
No playlist file will be created.

mp³

Change Options...

Output Folder

\\ASHSRVDATA01\Userdata\mve\Music\

Browse...

Path Params

- Album Name
- Artist Name

Params

- Track Number
- Artist Name
- Album Name

Silhouette \ 01 The Longest Time.mp3
Silhouette \ 02 Yours.mp3
Silhouette \ 03 Missing You.mp3
Silhouette \ 04 Mai Keed Fai Gub Dork TarnTaWan.mp3
Silhouette \ 05 Up & Rising (Keep doin' what you feel).mp3

Customize

%ALBUM%\%TRACK% %TITLE%

Add Placeholder

Help Home Create Quick Start < Back Rip >

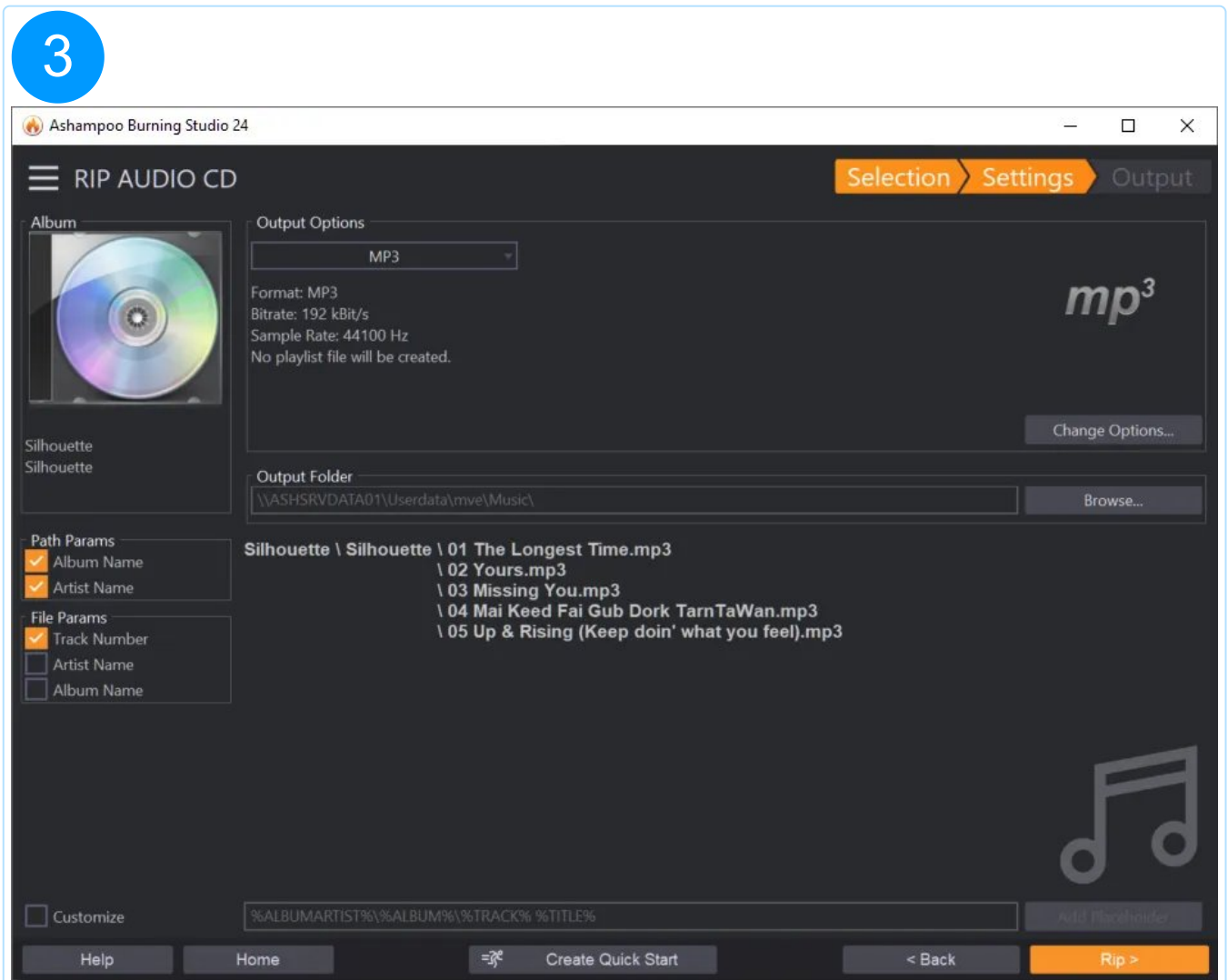

For additional flexibility, you can input individual placeholders manually, either through the keyboard or the "Add Placeholder" button. For example, "%TITLE%" means that each song title will later be inserted at the current cursor position. Make sure to place the cursor at the desired position in textfield before selection a placeholder. Naturally, you can also use a separator other than "\", e.g. "-". In this case, no additional subdirectories will later be created.

Ashampoo Burning Studio 24

Selection Settings Output

RIP AUDIO CD

Album



Silhouette
Silhouette

Output Options

MP3

Format: MP3
Bitrate: 192 kBit/s
Sample Rate: 44100 Hz
No playlist file will be created.

mp³

Change Options...

Output Folder

\\ASHSRVDATA01\Userdata\mve\Music\

Browse...

Path Params

- Album Name
- Artist Name

File Params

- Track Number
- Artist Name
- Album Name

Silhouette \ Silhouette \ 01 The Longest Time.mp3
 \ 02 Yours.mp3
 \ 03 Missing You.mp3
 \ 04 Mai Keed Fai Gub Dork TarnTaWan.mp3
 \ 05 Up & Rising (Keep doin' what you feel).mp3



Customize

%ALBUMARTIST%\%ALBUM%\%TRACK% %TITLE%

Add Playlist...

Help Home Create Quick Start < Back Rip >



Ashampoo Burning Studio 24

Selection Settings Output

RIP AUDIO CD

Album



Silhouette
Silhouette

Path Params

- Album Name
- Artist Name

File Params

- Track Number
- Artist Name
- Album Name

Output Options

MP3

Format: MP3
Bitrate: 192 kBit/s
Sample Rate: 44100 Hz
No playlist file will be created.

mp³

Change Options...

Output Folder

\\ASHSRV\DATA01\Userdata\mve\Music\

Browse...

Silhouette \ Silhouette \ 01 The Longest Time.mp3
 \ 02 Yours.mp3
 \ 03 Missing You.mp3
 \ 04 Mai Keed Fai Gub Dork TarnTaWan.mp3
 \ 05 Up & Rising (Keep doin' what you feel).mp3



Customize %ALBUMARTIST%\%ALBUM%\%TRACK% %TITLE%

Add Placeholder

Help Home   Create Quick Start < Back Rip >

Ashampoo Burning Studio 24

Selection Settings Output

RIP AUDIO CD

Album



Silhouette
Silhouette

Path Params

- Album Name
- Artist Name

File Params

- Track Number
- Artist Name
- Album Name

Output Options

MP3

Format: MP3
Bitrate: 192 kBit/s
Sample Rate: 44100 Hz
No playlist file will be created.

mp³

Change Options...

Output Folder

\\ASHSRVDATA01\Userdata\mve\Music\

Browse...

Silhouette \ Silhouette \ 01 The Longest Time.mp3
 \ 02 Yours.mp3
 \ 03 Missing You.mp3
 \ 04 Mai Keed Fai Gub Dork TarnTaWan.mp3
 \ 05 Up & Rising (Keep doin' what you feel).mp3



Customize

%ALBUMARTIST%\%ALBUM%\%TRACK% %TITLE%

Add Placeholder

Help Home Create Quick Start < Back



Ashampoo Burning Studio 24

Selection Settings Output

Album

Silhouette
Silhouette

Path Params

- Album Name
- Artist Name

File Params

- Track Number
- Artist Name
- Album Name

Output Options

MP3

Format: MP3
Bitrate: 192 kBit/s
Sample Rate: 44100 Hz
No playlist file will be created.

mp³

Change Options...

Output Folder

\\ASHSRVDATA01\Userdata\mve\Music\

Browse...

Silhouette \ Silhouette \ 01 The Longest Time.mp3
 \ 02 Yours.mp3
 \ 03 Missing You.mp3
 \ 04 Mai Keed Fai Gub Dork TarnTaWan.mp3
 \ 05 Up & Rising (Keep doin' what you feel).mp3

Customize

%ALBUMARTIST%\%ALBUM%\%TRACK% %TITLE%

Help Home Create Quick Start < Back

- Artist
- Album Artist
- Album
- Track Number
- Track Count
- Extension
- Title
- Genre
- Year
- Generate
- Read Speed
- Channel
- Quality

Ashampoo Burning Studio 24

Selection Settings Output

RIP AUDIO CD

Album



Silhouette
Silhouette

Output Options

MP3

Format: MP3
Bitrate: 192 kBit/s
Sample Rate: 44100 Hz
No playlist file will be created.

mp³

Change Options...

Output Folder

\\ASHSRV\DATA01\Userdata\mve\Music

Browse...

Path Params

- Album Name
- Artist Name

File Params

- Track Number
- Artist Name
- Album Name

Silhouette \ 1997Silhouette \ 01 The Longest Time.mp3
 \ 02 Yours.mp3
 \ 03 Missing You.mp3
 \ 04 Mai Keed Fai Gub Dork TarnTaWan.mp3
 \ 05 Up & Rising (Keep doin' what you feel).mp3



Customize %ALBUMARTIST%\%YEAR%\%ALBUM%\%TRACK% %TITLE%

Add Placeholder

Help Home Create Quick Start < Back Rip >



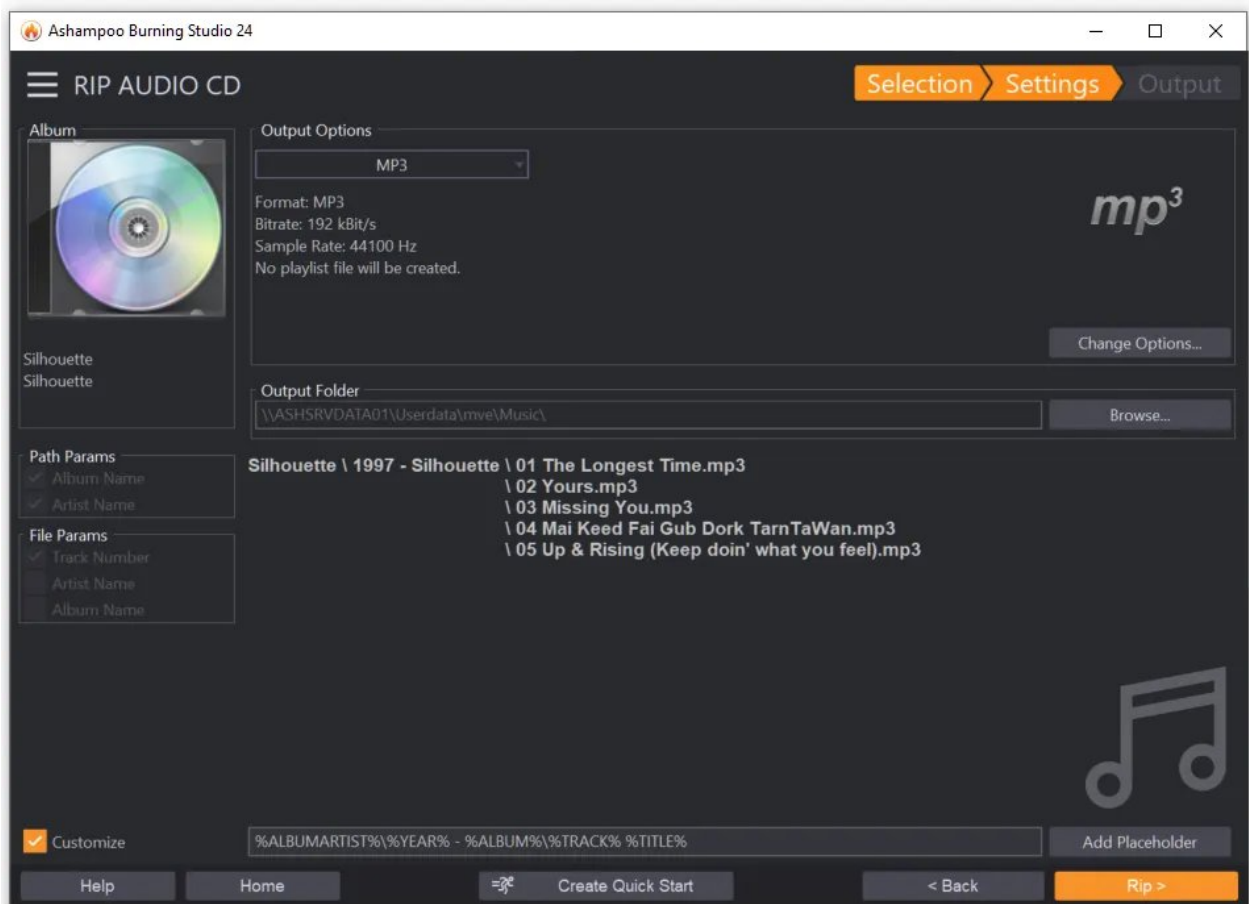

4.4.3 Ripping status

The status of the ripping process is presented visually.

4.4.4 Quick Rip Audio CD

Quick ripping follows the same procedure as normal ripping but skips drive selection by automatically selecting the drive that currently holds an audio disc. Instead, you're immediately presented with the [track selection](#) page. [Settings](#) concerning track naming

and audio quality are still accessible through a separate button but not part of the default process. This way, skipping a total of two steps allows you to rip audio discs faster.

4.4.5 Reduce number of files

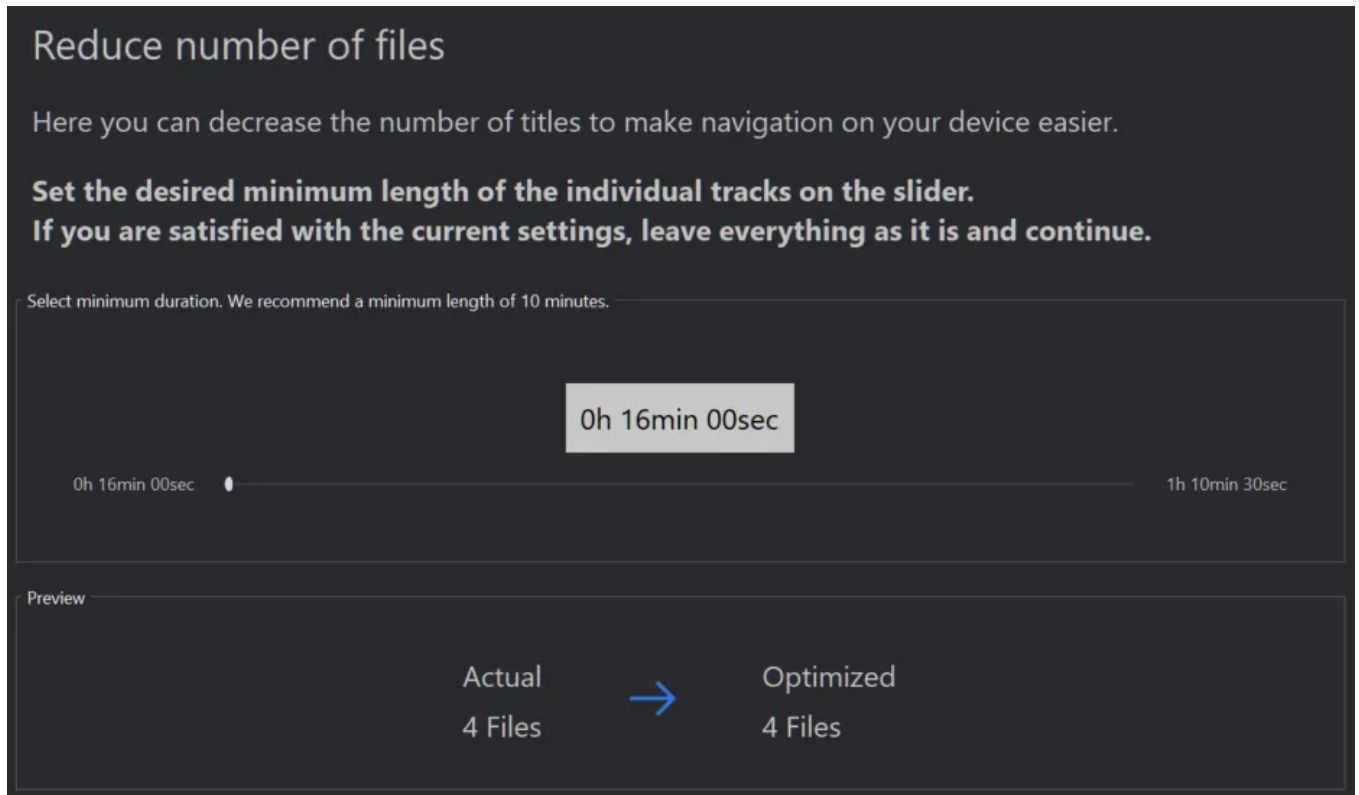

Some players don't save the playback position so you'll have to manually adjust it every time you resume a recording. This can be a hassle, especially with smaller files. The program allows you to merge individual files to make this task easier. Simply drag the slider to adjust the minimum file length. The bottom panel shows the number of files before and after merging. Drag the slider all the way to the left to leave the original files untouched.

4.5 Audiobook

Finally, select your target drive and start the writing process.

This module sorts and names files that are part of an audiobook fully automatically. Simply use the plus button add your files or drag and drop them into the program via Windows Explorer. Use the [cover search](#) to find suitable coverart for your audiobooks.

4.5.1 Create Audiobook

Simply select the target drive and start the write process.

4.6 Create audio disc for car / player

No matter whether you're creating a playable USB stick, a CD, an SD card or a DVD, the procedure is always the same. First, select your radio model from the list. It displays devices sorted by manufacturer and model and also lists the supported media types and audio formats for each device. If your model is not listed, you can either select a "Generic" preset or create your own by clicking "[My radio isn't available](#)". Use the buttons to the right of the list to edit or delete one of your own presets.

4.6.1 My radio isn't available

If your model is not listed among the default entries, you can create your own preset. First, enter the name of the manufacturer and model. Enable "Expert mode" to modify advanced settings such as supported file systems and folder depth.

4.6.1.1 Create copy from

If needed, you may copy and modify one of the default presets.

Select media type

Use this dialog to select the media types your radio supports.

Select formats

Select the audio formats supported by your radio here. If you enabled "Expert mode" this setting will appear at a later stage.

Summary

Finally, you will be presented with a brief summary of your settings.
med_CMovieditorSelectMusicDialog

Select playlist format (expert mode)

Select the playlist formats supported by your device here. You may also specify the maximum number of playlists and their lengths. If your device supports it, you may also enable subfolder references. Use the dropdown menu to select a format into which non-supported playlists will automatically be converted.

Select file system settings (expert mode)

Then, adjust the file system settings to your needs. Consult the technical documentation for your radio for details on supported features.

Select filetag version (expert mode)

Depending on the selected file types, you may now specify which filetag specifications are supported by your device. File tags are used to display additional song details such as artist and genre. Enable "Supports cover art" to preserve cover images that were stored in your songs.

Summary

Finally, you will be presented with a brief summary of your settings.

4.6.2 Select destination

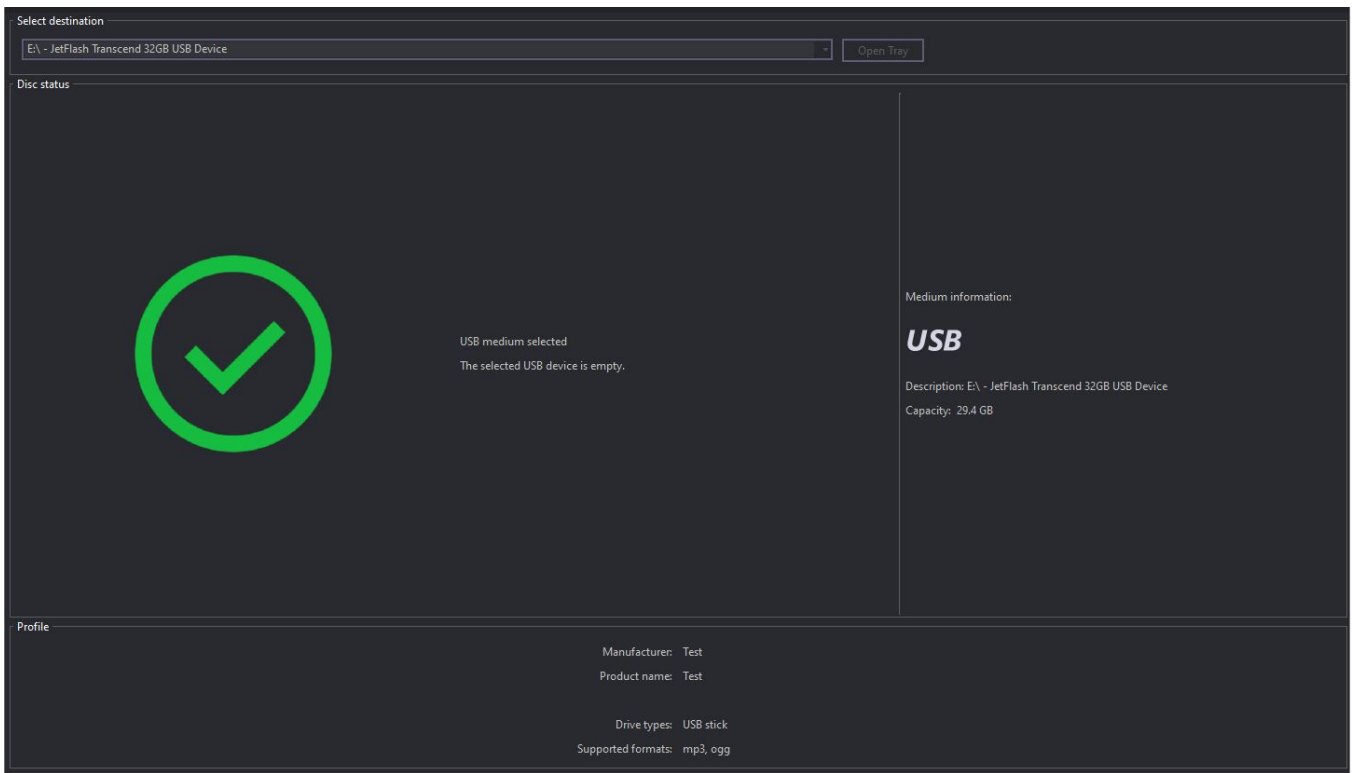

Then, select the target.

4.6.2.1 Add files



Use this dialog to add songs and, depending on your settings, folders to your compilation.

Toolbar

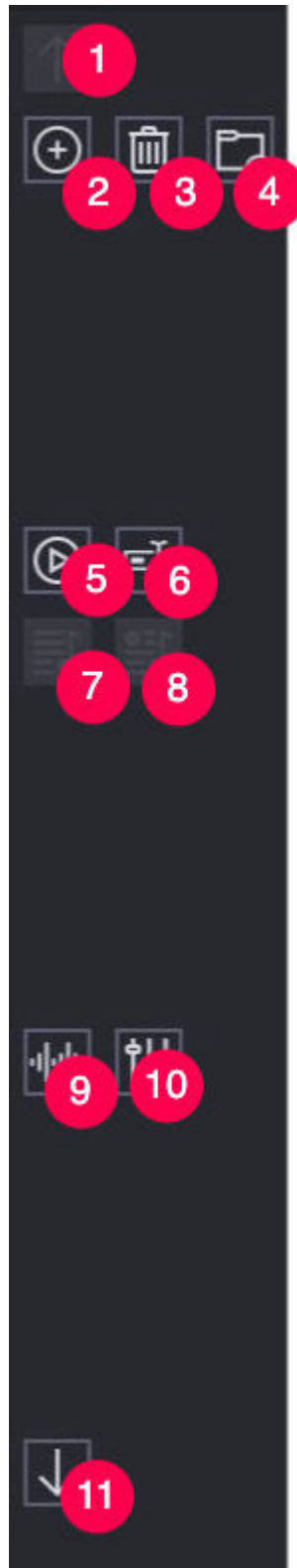

Up Moves the selected song one place up.

Add Adds a song or song folder to your compilation.

Delete Deletes the selected entries from your project.

Create folder	Creates a new folder. This feature is only available, when current file system settings support it and the maximum folder depth has not already been reached.
Play	Plays the selected song in the integrated audio player.
Rename	Renames the selected entry.
Create playlist	Creates a new playlist from the current compilation. Click here for details.
Edit playlist	Edits an existing playlist. Click here for details. Note that this feature currently only works with playlists that were created through "Create playlist".
Output settings	Allows you to specify the bitrate and apply automatic or custom volume normalization. Click Output settings for details.
Equalizer	Click here for details.
Down	Moves the selected song one place down.

Create playlist

Enter the name for the new playlist here.

Edit playlist

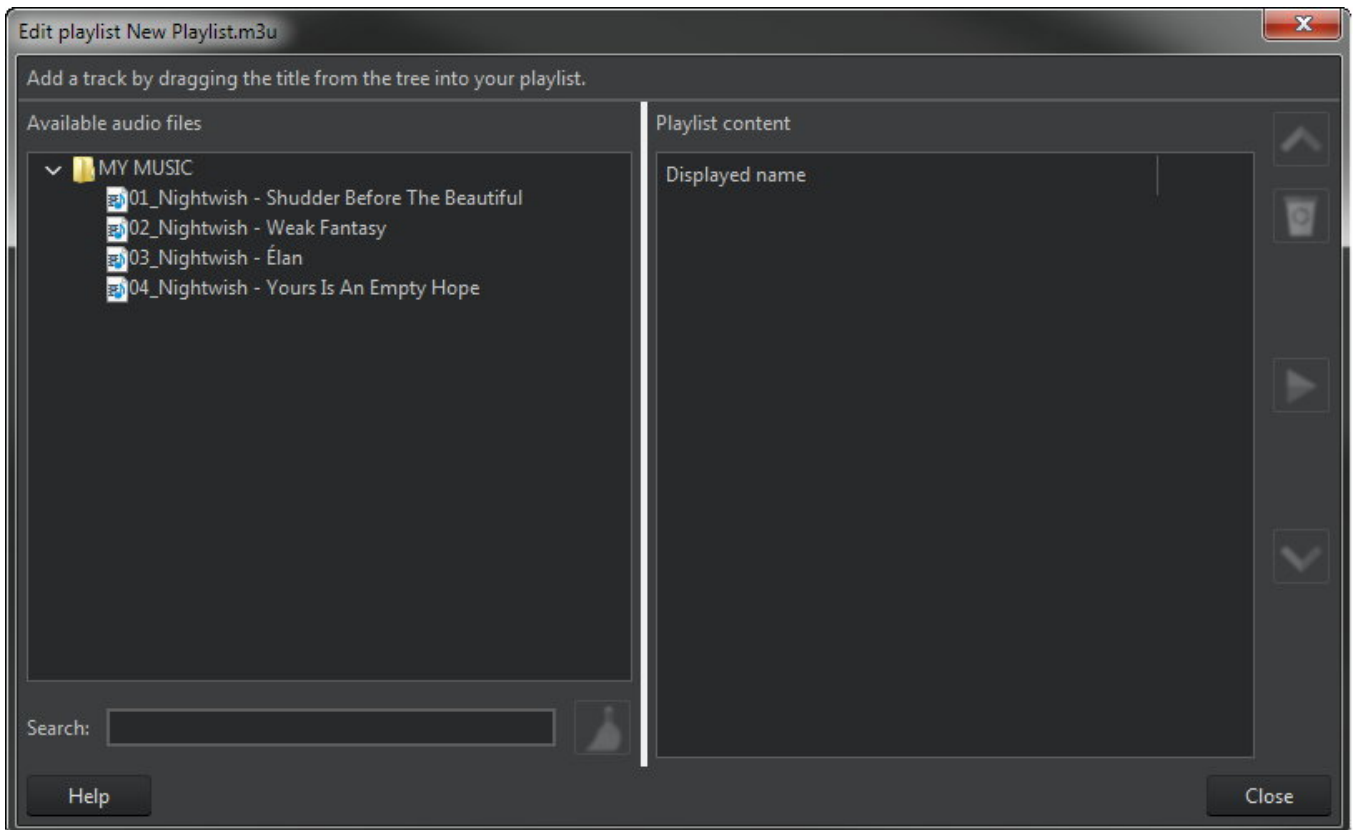

Drag the songs to be included in your playlist into the list on the right. Use the buttons to move songs up/down by own place, play them or delete them from the playlist.

Output settings

These settings allow you to modify the bitrate (higher = better quality but higher memory consumption). You can also apply volume normalization that will equalize the volume across your songs. Automatic normalization uses the average volume from your songs but you can also define the dB threshold manually.

Create medium

Finally, your songs will be copied/burned to the medium you selected.

5. Movie + Slideshow

5.1 Create Movie / Slideshow DVD

First, input a title for your project.

5.1.1 Selecting a format

Then, select a screen format. Most modern TVs use a 16:9 aspect ratio. Usually, you don't have to adjust the TV system settings as the program will pick a suitable setting for your region automatically.

5.1.2 Adding videos

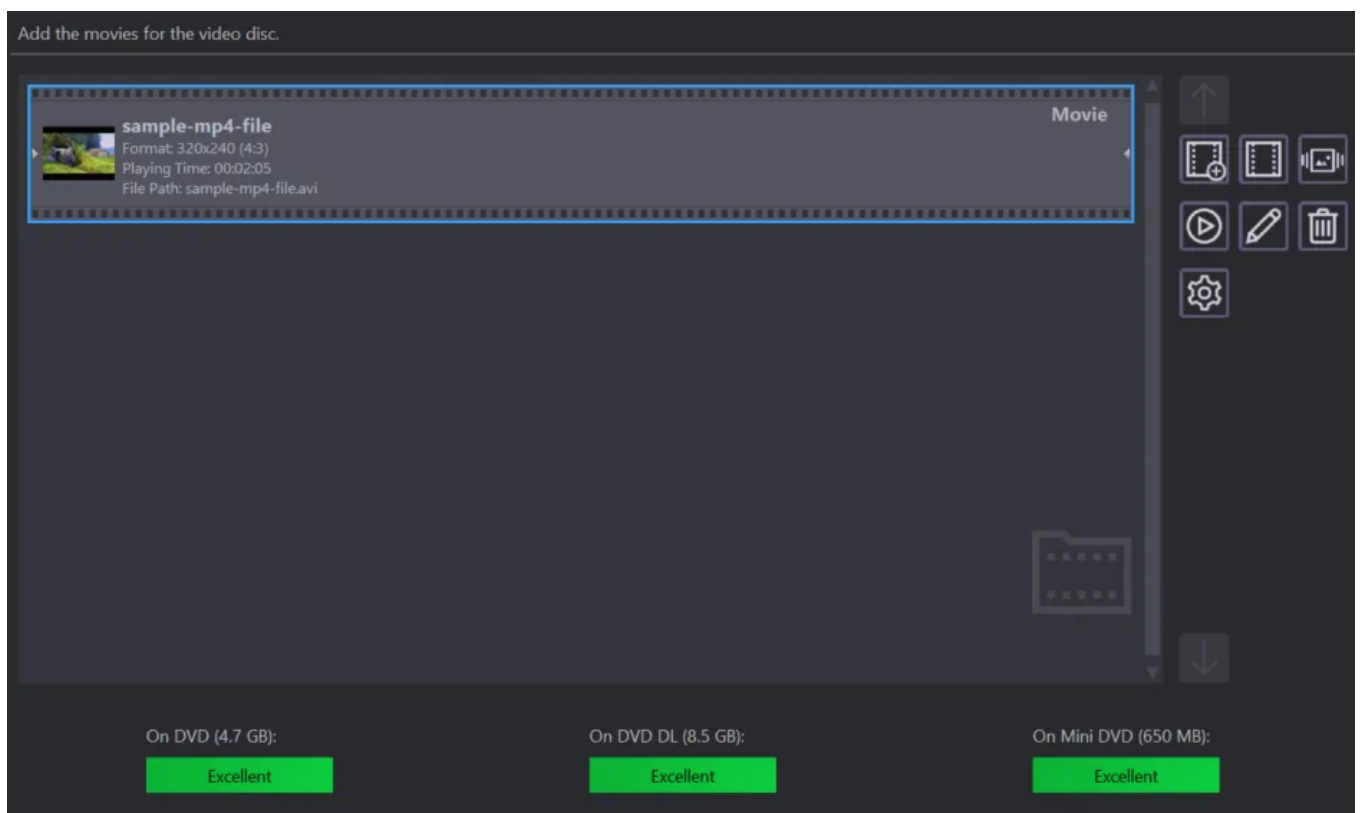

Now, add the video clips to be included on the disc. The indicators at the button provide details on the potentially achievable quality for each disc type.

Add Movie Adds a video to the project.

Create Movie Allows you to create movies from videos and images. More on that [here](#).

- Create Slideshow** Enables you to create slide shows. More on that here.
- Edit** Allows you to edit the selected file.
- Movie settings** Click here for details.
- Remove** Removes the selected entry from the project.
- Play** Plays the selected video.
- Move Up** Moves the entry one row up.
- Move Down** Moves the entry one row down.

5.1.2.1 Create / Edit Movie

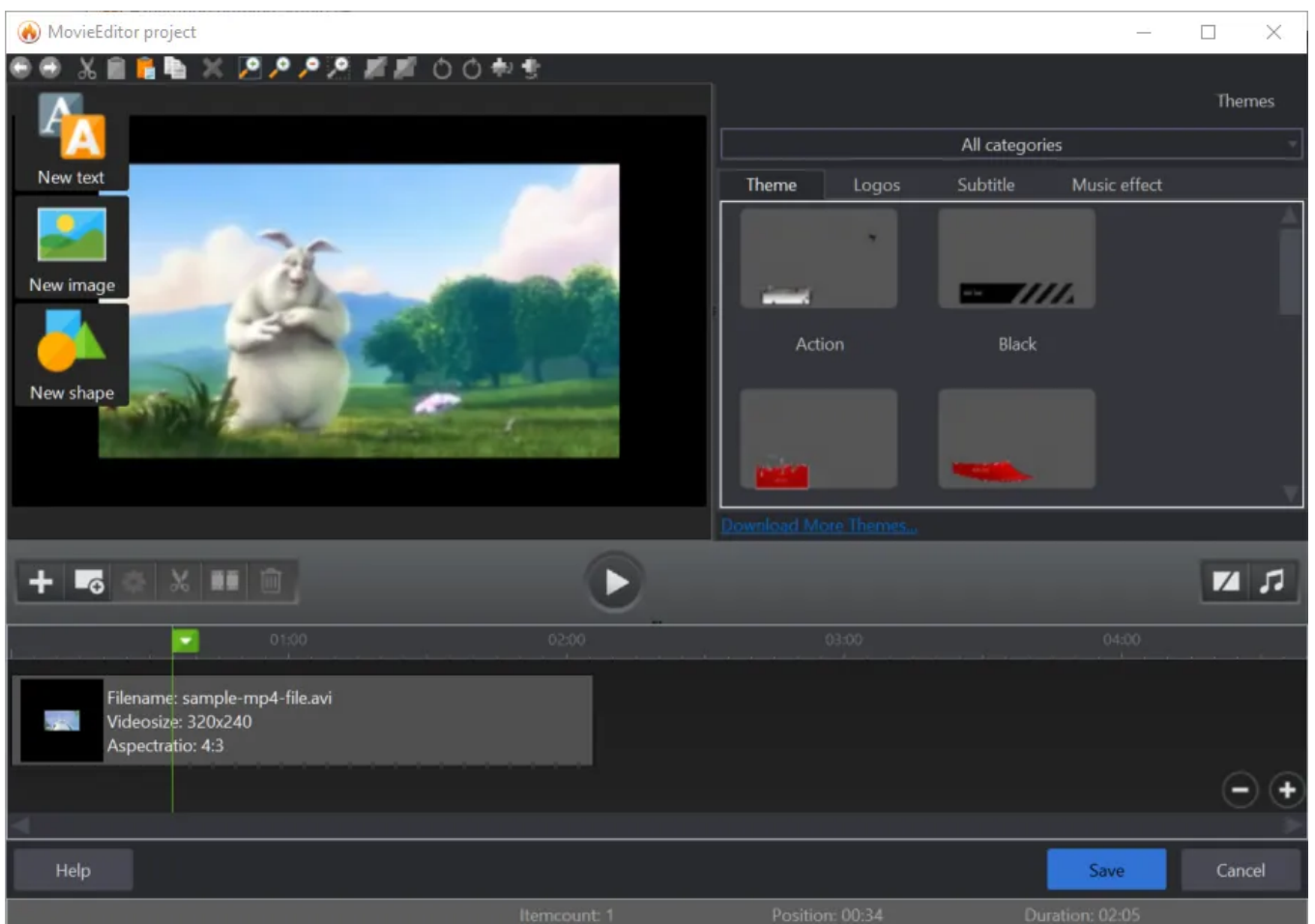

MovieEditor allows you to cut existing videos and add texts, images and transitions.

Frame preview

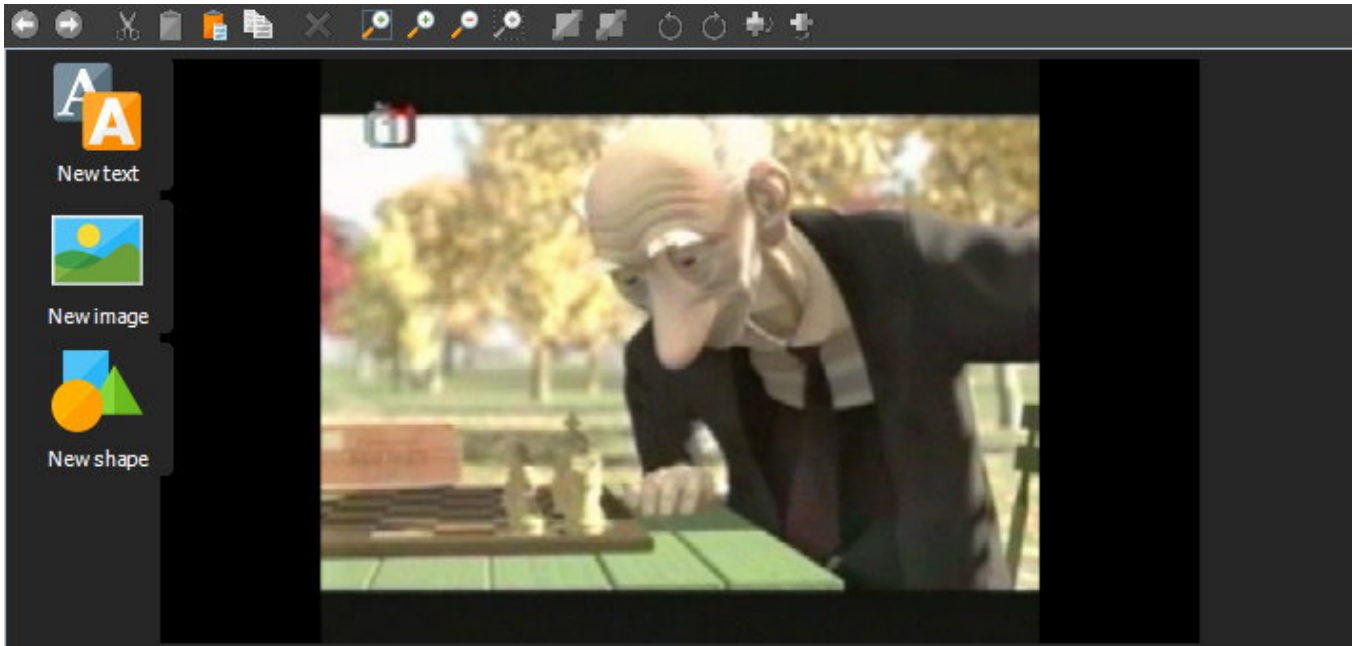

Toolbar

Undo	Undoes the last operation.
Redo	Redoes the last undone operation.
Cut	Cuts the current object and copies it to the system clipboard.
Copy	Copies the current object to the system clipboard.
Paste	Pastes the currently copied object into the menu.
Duplicate	Creates a copy of the selected object.
Delete	Deletes the selected object.
Zoom all Objects	Adjusts the zoom so that all objects are visible on the screen.
Zoom In	Zooms into the design.
Zoom Out	Zooms out of the design.
Zoom selection	Zooms into the selection.
Send to front	Sends the selected object to the front.
Send to back	Sends the selected object to the back.
Rotate left	Rotates the selected object 90° left.
Rotate right	Rotates the selected object 90° right.

Mirror vertically Mirrors the selected object vertically.

Mirror horizontally Mirrors the selected object horizontally.

Working with objects



Left-click an existing to object to select it. Drag the border markers to adjust the size and the center marker to adjust the position of the object. Drag the circular marker to rotate the object. Double-click an object to edit it or use the right-click context menu.

New text Creates a new text object and opens the text editor.

New image Allows you to add in image object.

New shape Opens the shape editor and enables you to create a shape object.

Timeline

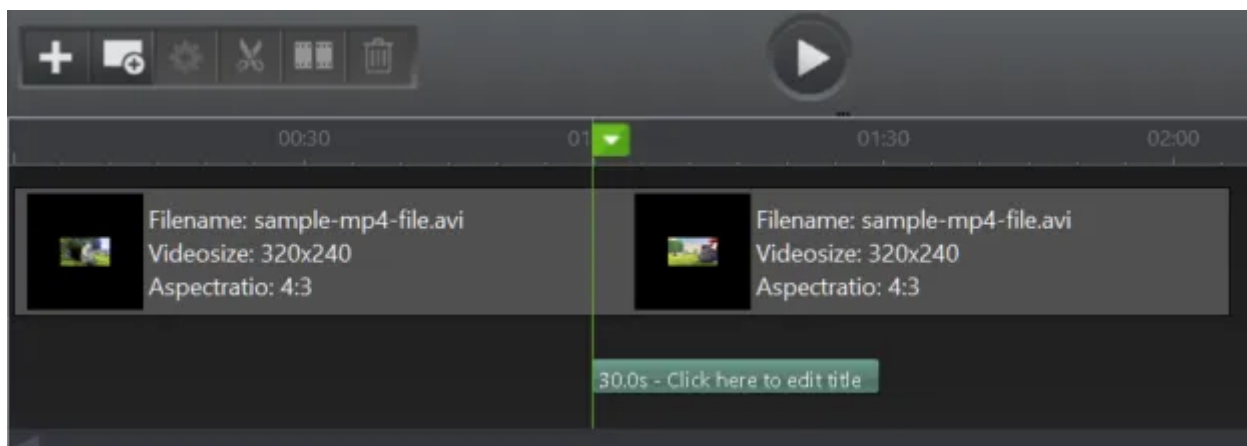

Video editing is done in this area. Click to reposition the marker. Click an object to select it. Depending on the object type different buttons will become available.

Toolbar

Add	Adds a video or image to the project.
Add blank item	Adds an empty area that can be used as a background for text objects. More on that here .
Edit / Start-/Endtime	Opens the object display settings or allows you to adjust the start and end times of your videos.
Cut areas	Allows you to remove individual frame ranges from a video. More on that here .
Split video	Enables you to split a video. More on that here .
Delete	Removes an object/video from the timeline.
Play	Starts video playback from the current marker position.
Transition	Sets the transition effect for video clips and images throughout the project. More on that here .
Music	Allows you to add audio files to use as background music in your movie. More on that here .

You can also right-click a video/image in the timeline to access many of the above functions through a context menu.

Editing objects

Objects are displayed as bars with a time value. The length of the bar correlates directly with the display duration. Drag the edges to adjust it or drag the bar to reposition it.

Right-click an existing object to delete it or to [adjust its display duration](#).

Themes and music effects

Aside from "Music effect", these are all objects or object combinations that include text and image elements. Double-click an entry to add it to the timeline. Like all other objects, these objects are also freely resizable and positionable. "Music effects" are short audio clips that can be positioned by dragging their bar displays in the timeline.

Changing object display times

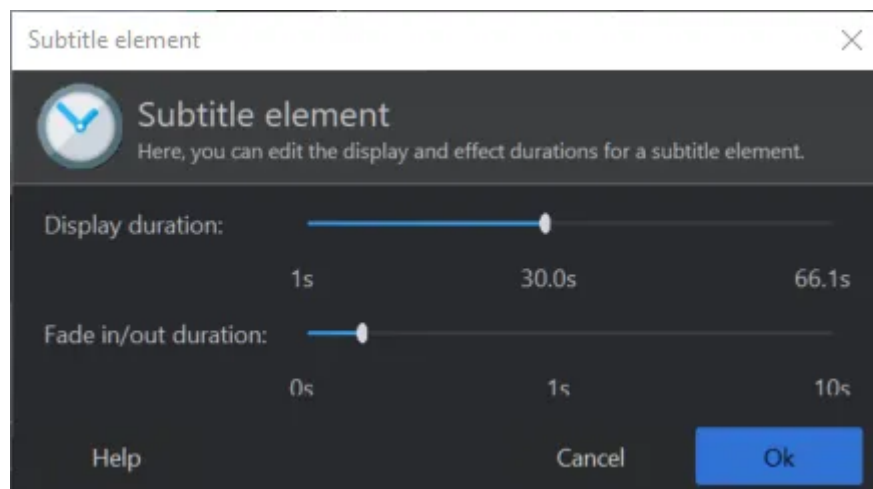

"Element duration" modifies the length of the bar display while "Fade In-/Out Duration" affects the time it takes for elements to become (in)visible.

5.1.2.2 Edit blank item

Empty elements are ideal to present additional information such as text in between movie scenes. Simply select a color or apply a circular gradient.

5.1.2.3 Define start- / endtime

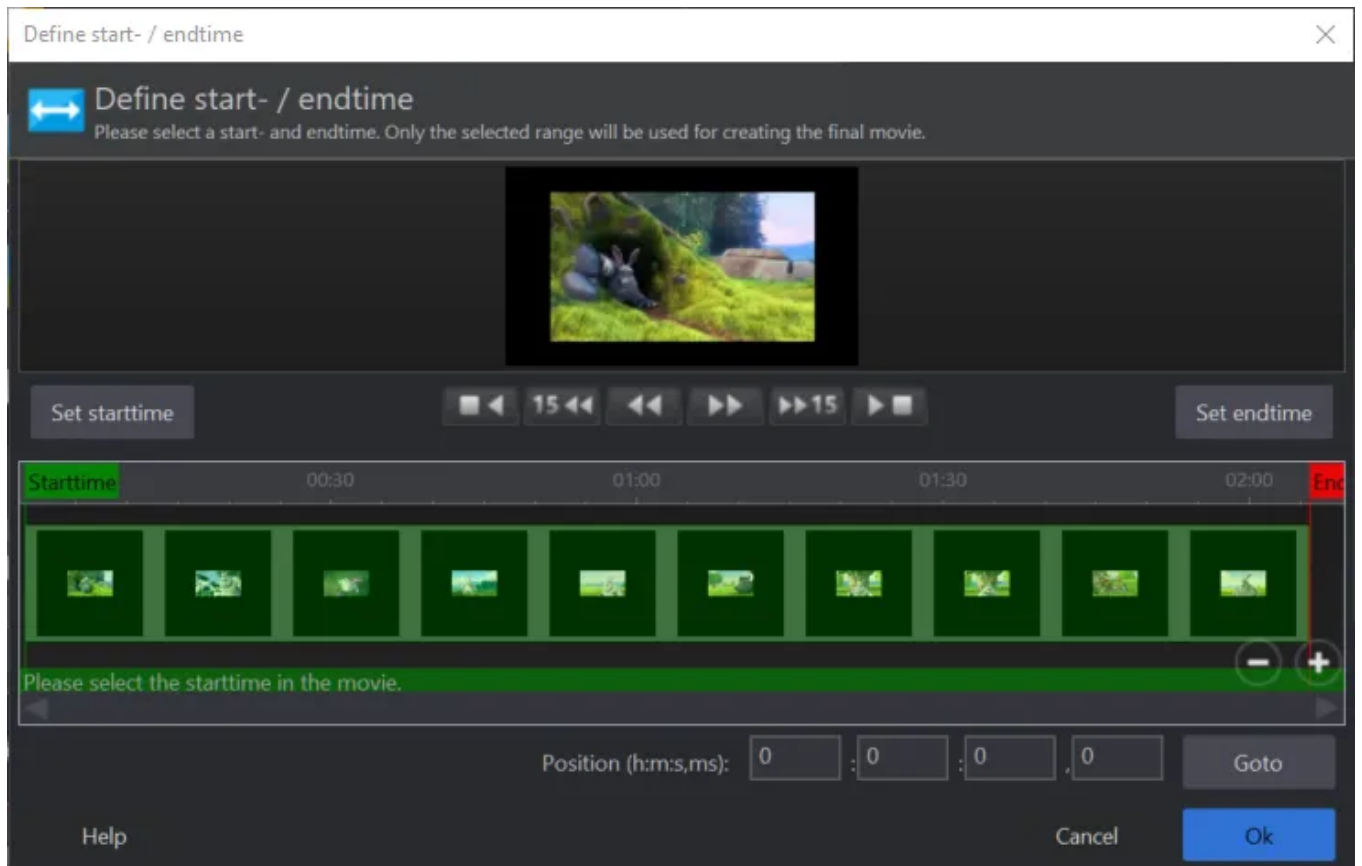

Hit "Set start time" and click into the timeline to place the marker. Then, hit "Set endtime" and position the second marker. Instead of clicking, you may also use the bottom text areas to position the markers.

5.1.2.4 Cut areas

Hit "Set start time" and click into the timeline to place the marker. Then, hit "Set endtime" and position the second marker. Instead of clicking, you may also use the bottom text areas to position the markers. Click "Remove area" remove the selected frame range.

5.1.2.5 Split video

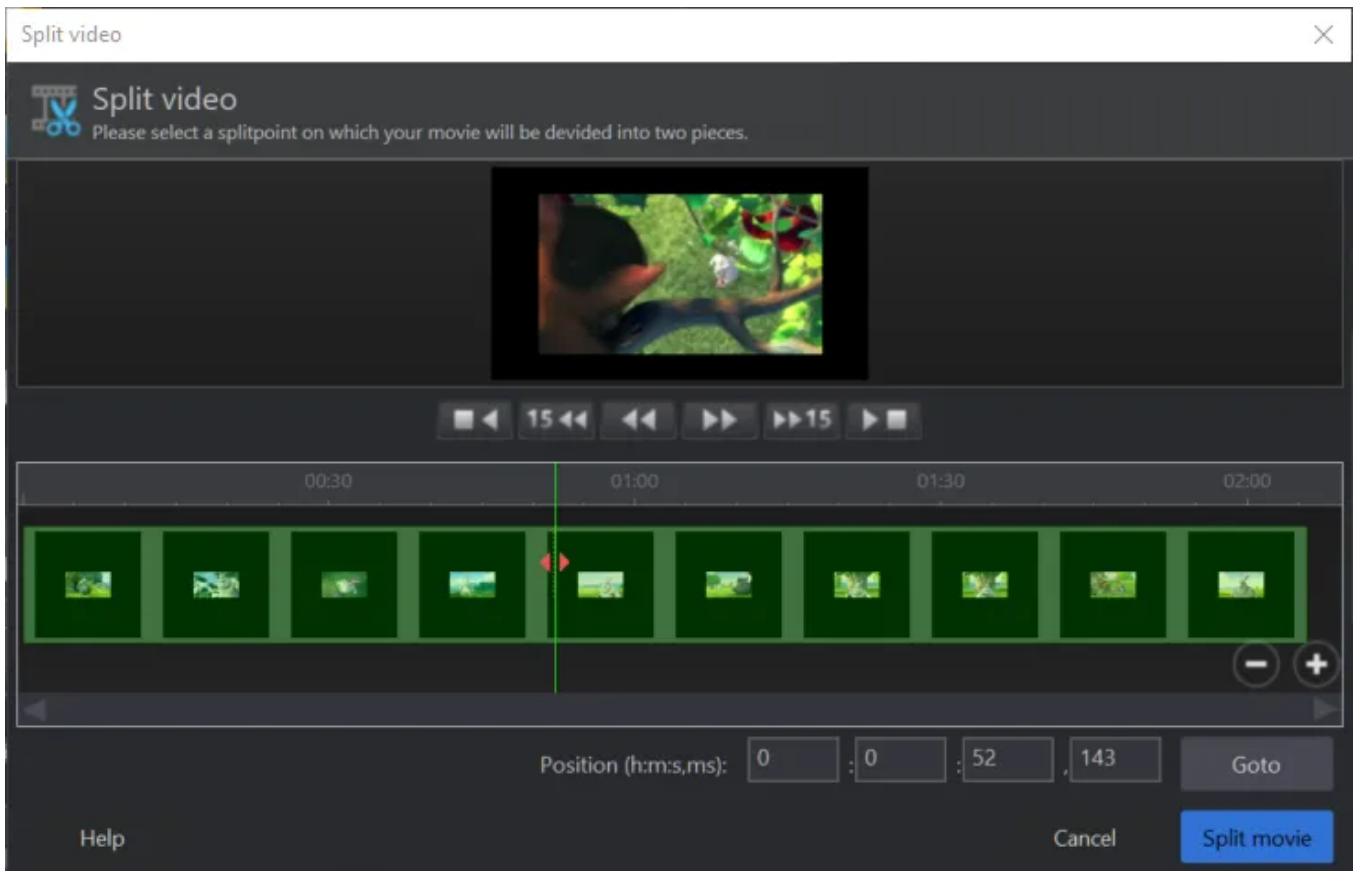

Click to position the cut mark and hit "Split movie" to make the cut. You may also use the bottom text areas to position the marker.

5.1.2.6 Adjusting transitions

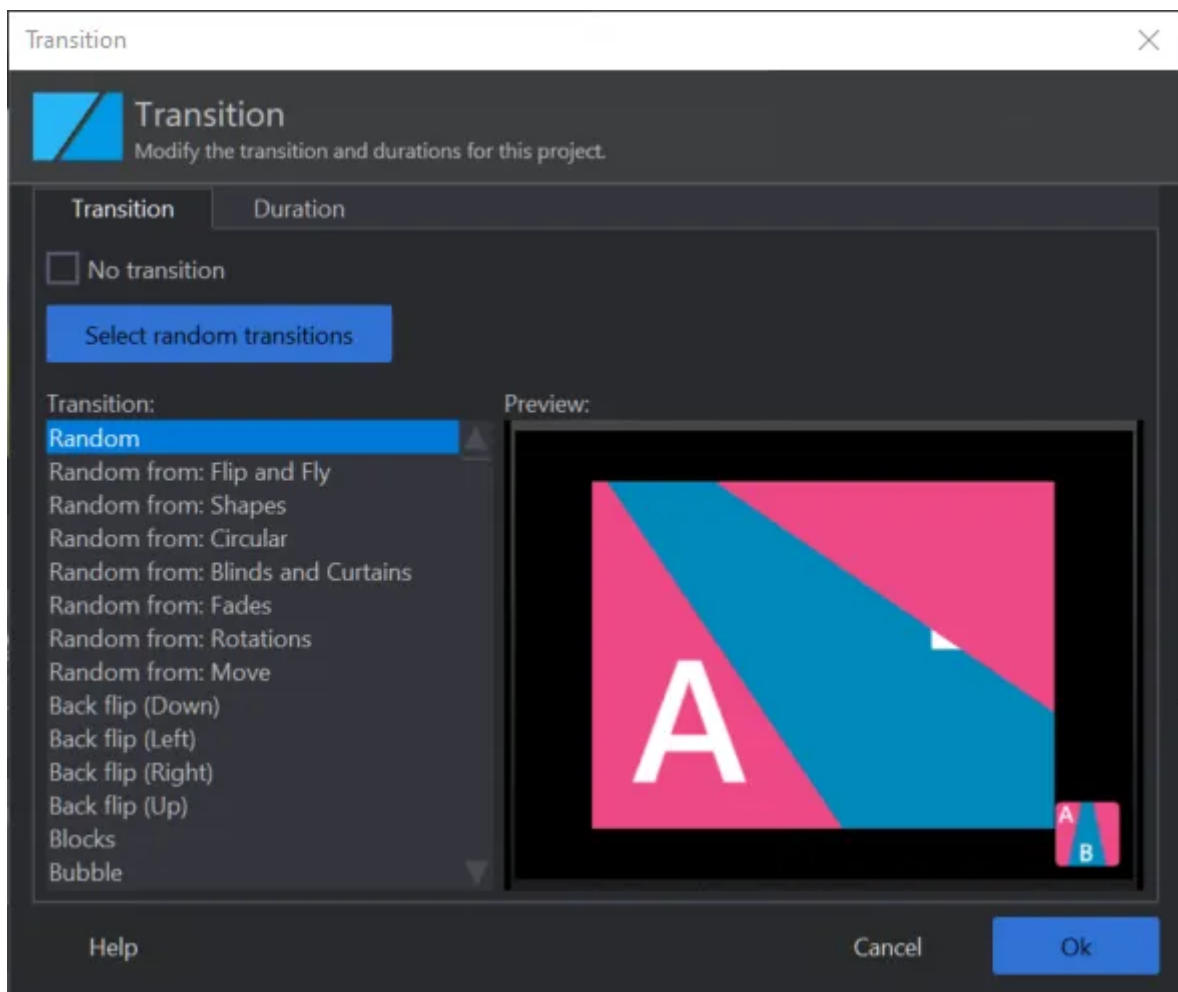

These settings apply to all transitions throughout the project. Transitions will be applied automatically in between video/image segments. Use the slider to adjust the duration of all transitions.

5.1.2.7 Adding music

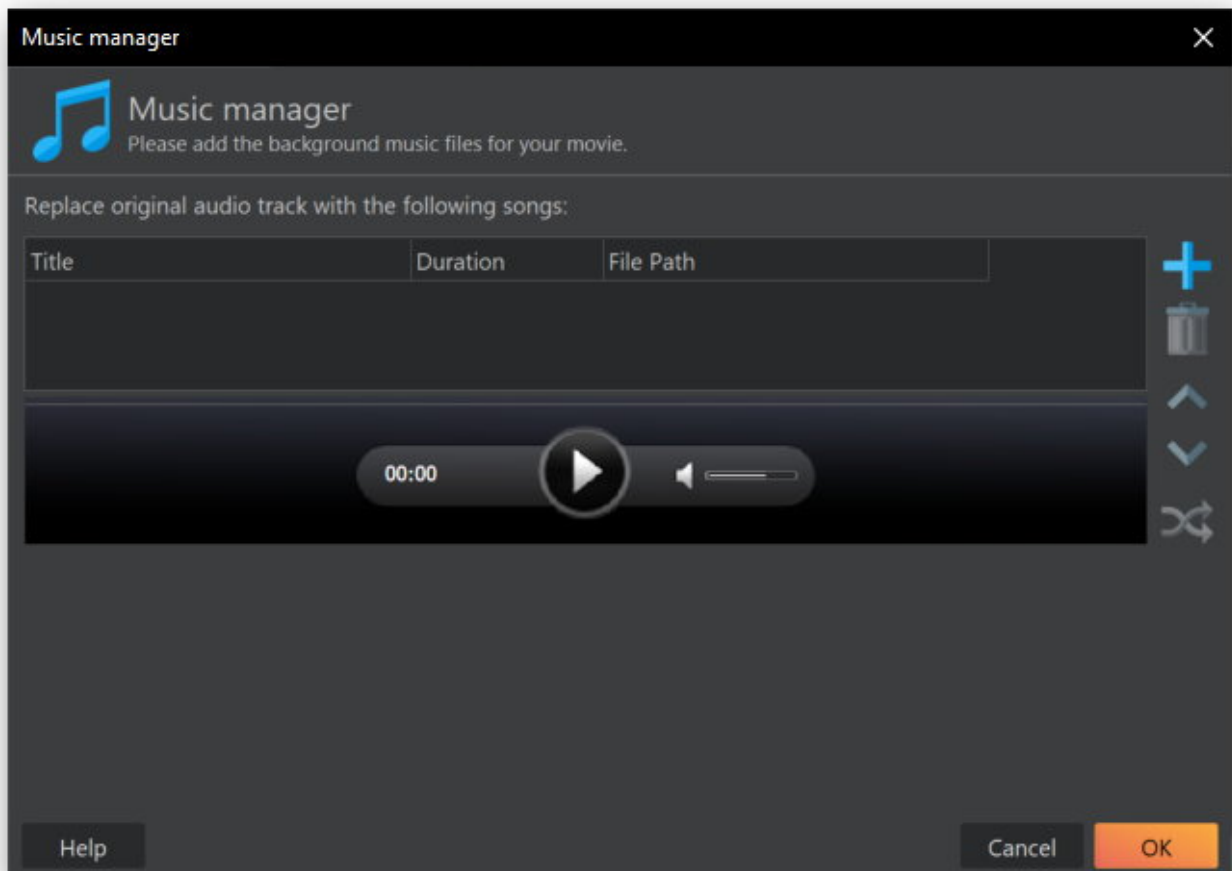

You may add multiple songs to be used as background music.

- Add** Adds a song to the playlist.
- Remove** Removes the selected song from the playlist.
- Move Up** Moves the selected song up by one spot in the playlist.
- Move Down** Moves the selected song down by one spot in the playlist.
- Randomize** Shuffles the available songs.

5.1.2.8 Movie settings

Use the text field to name your movie.

Menu-Entry

Enable this setting to include an entry for each added video in the disc menu to make navigation easier.

Treat as 16:9

Use this setting in case the program incorrectly recognizes your 16:9 videos as 4:3.

Normalize audio track

Enable this setting to adjust the volume levels of all audio tracks around a common level.

Rotation

Select the amount of degrees by which to rotate your video here.

Place a chapter in a fixed interval

Use this setting to split your movie into several fixed-size chapters. This setting only applies to Blu-ray projects.

Use subtitle file

You can add SRT-based subtitles to your movies. Simply click open and select the SRT file. Existing subtitle files are easily found throughout the Internet.

5.1.2.9 Create Slideshow

Once the application has opened, the project wizard will appear to help you create your slideshow.

- New simple project** Guides you through the various steps to creating your slideshow with music and overlay effects. [More on that here.](#)
- New project** Creates a new empty project.

New simple project

First, select the theme to use with your project or select "No Theme".

Select slideshow mode

- Freestyle** The total length of the slideshow will not automatically adapt to song lengths or number of images.
- Adapt to music** The total length of the slideshow automatically adapts to the length of the added songs. Use the plus to add songs, the trash can to remove them and the arrow buttons to modify the playback sequence.
- Adapt to time** The total length of the slideshow automatically adapts to the number of added images. Either select a value preset or input your own time in seconds/minutes.

5.1.2.10 Settings

- Energy Level** Use this slider to set the degree of action/movement for your slideshow.
- Transitions/Ken Burns** Either select a fixed transition/Ken Burns effect for all of your slides or select "random" to have multiple different effects. Use "Customize" to narrow down the selection of available

effects for the random setting. [Click here](#) for details on Ken Burns effects.

Background Track

Use these buttons to add songs to your project as background music, remove individual entries or adjust the playback sequence.

5.1.2.11 Add files

This dialog allows you to add images to your project, modify the playback sequence and add individual recordings/subtitles.

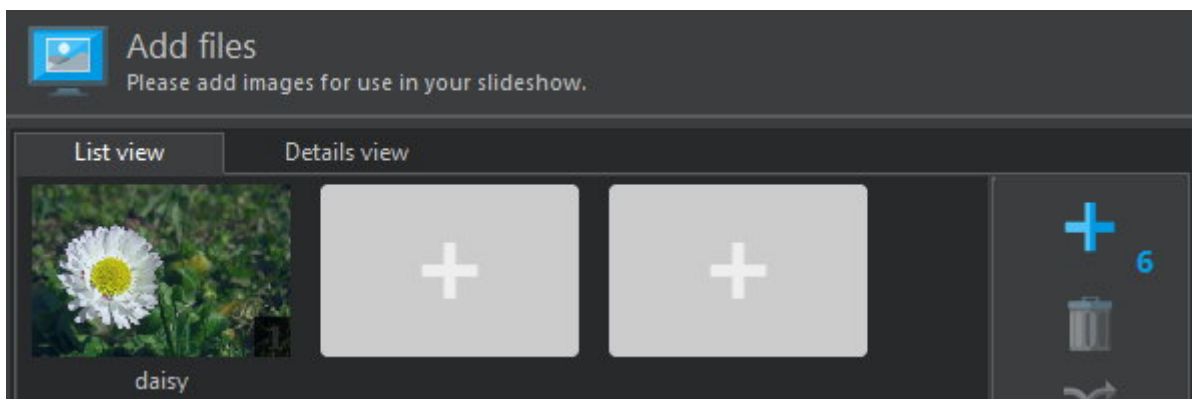

If you selected to have the length of your slideshow adapt to music or a fixed time value, the program will display an indicator next to the plus button that represents the ideal number of images you should add to your project. Naturally, you can always add more/less images and have the program adjust their display durations to fit your settings.

List view This view allows you to add images to your project, rotate them and to add subtitles and individual recordings. Note that several buttons are only available once you add and select images. Hold down Shift to select all images between the first and second clicked image or hold down Ctrl to individually select multiple images.

Details view This view displays a magnified view of your images and provides arrows for easy navigation.

Recording Records audio from a registered Windows recording device, e.g. a microphone. More on that [here](#). Use the trash can button to remove an added recording.

Image subtitle Use this text field to add a subtitle to the selected image that will latter be added as a text object to your slideshow.

Record

Select a recording device and click "Start recording" to begin the process. Click "Stop recording" to finish it. Use the bottom player to preview your recording. Once you click "Ok", your recording will be added to the selected image.

Preview

Here, you can preview your slideshow. Use "Randomize" to restart the preview with a new KenBurns effect unless you have selected a fixed effect on the page. Enable "Save the project file for the slideshow" to save your project to a file after this step.

5.1.2.12 Create/Edit slideshow

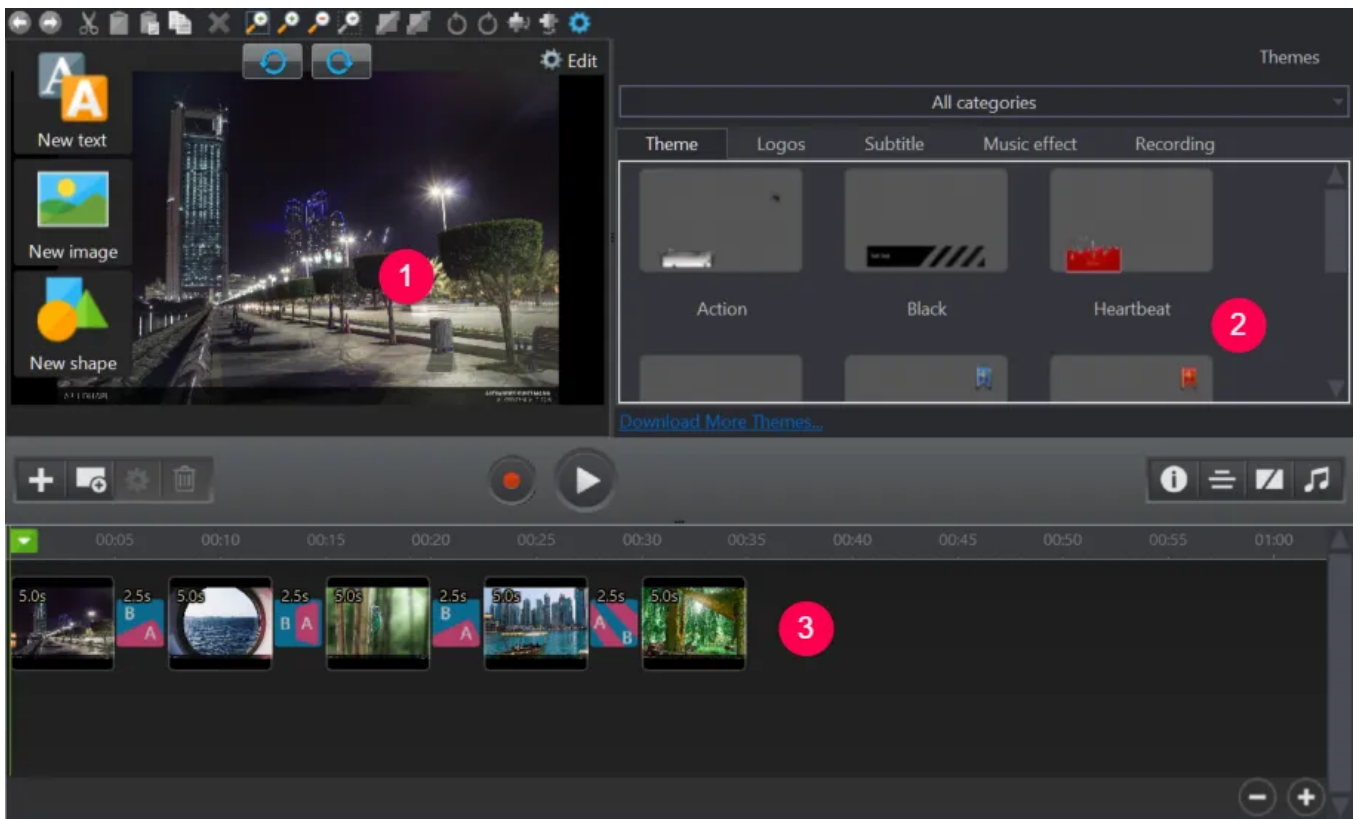

The editor consists of three areas:

1. **Slide editor** Here, you can edit the selected image and add objects such as text and graphic overlays.
2. **Timeline** This is where you can adjust the order of your slides, slide transitions and any added objects.
3. **Templates** These themes help you create an atmosphere through various styled presets

5.1.2.13 Edit slide

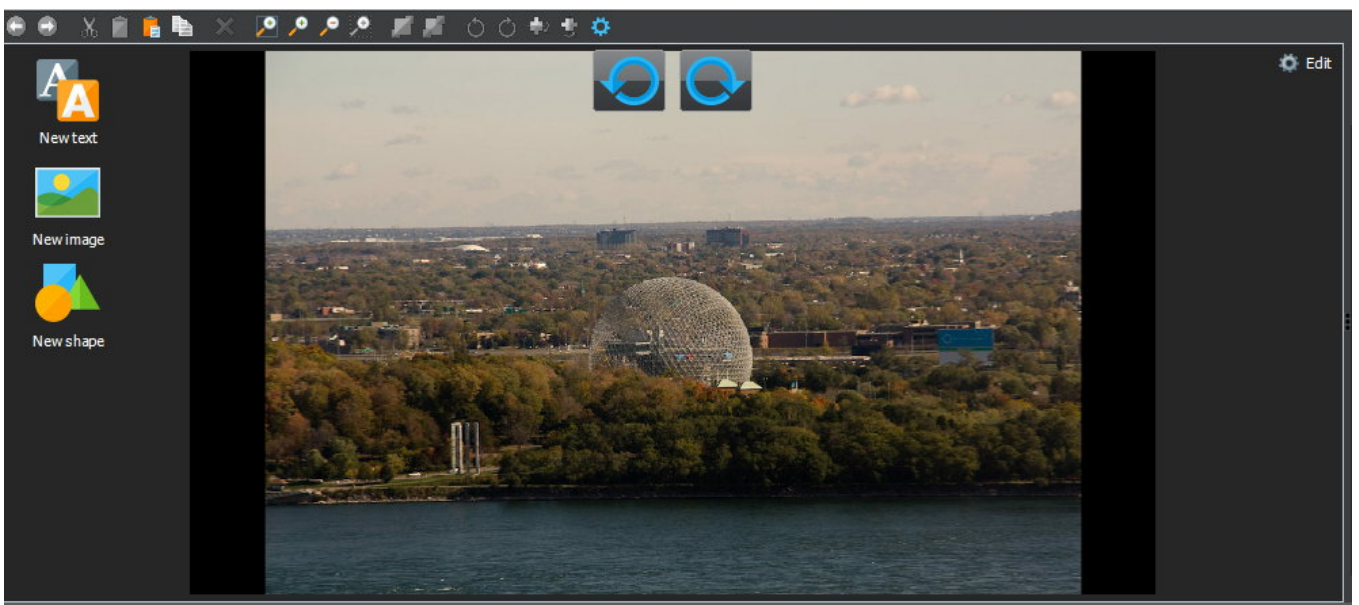

The slide editor enables you to apply image editing effects such as rotation as well as adding text, image and shape objects.

Toolbar



- Undo** Undoes the last action. Note that this feature only applies to actions in the slide editor and will not affect timeline changes.
- Redo** Redoes the last undone action. Note that this feature only applies to actions in the slide editor and will not affect timeline changes.

Cut	Copies the selected objects to the system clipboard and removes them from the image.
Copy	Copies the selected objects to the system clipboard.
Paste	Pastes the most recently copied objects at the current position.
Duplicate	Clones the selected objects.
Delete	Deletes the selected objects.
Zoom all Objects	Zooms out of the image until all objects are visible.
Zoom In	Zooms into the image.
Zoom out	Zooms out of the image.
Zoom selection	Zooms into the current selection.
Send to front	Moves the selected object to the highest position in the object hierarchy.
Send to back	Moves the selected object to the lowest position in the object hierarchy.
Rotate Left	Rotates the selected object 90° left.
Rotate Right	Rotates the selected object 90° right.
Flip vertically	Flips the selected object vertically.
Flip horizontally	Flips the selected object horizontally.
Settings	Allows you to adjust view and duration settings. Click here for details.

Working with objects

New text	Creates a new text object with individual font, size and color settings using the text editor .
New image	Inserts a local image file into your image. The added image will automatically be resized to not fill up the entire workspace. You may

freely resize the object if needed.

New shape Creates a shape object, e.g. a star, with custom outline, filling and transparency settings using the [shape editor](#).

Rotate left/right These buttons allow you to rotate the current image 90° left/right.

Click an object to select it or hold down Ctrl to select multiple objects in a row. Press Ctrl + A to select all objects. You may also drag to create a selection rectangle similar to selecting multiple files on your Windows desktop. Double-click an object to edit it.

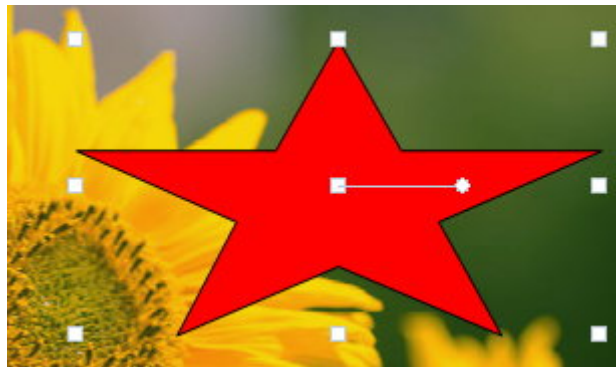

Moving objects

Simply left-click and hold within an object and move your mouse to reposition the object.

Visual guides

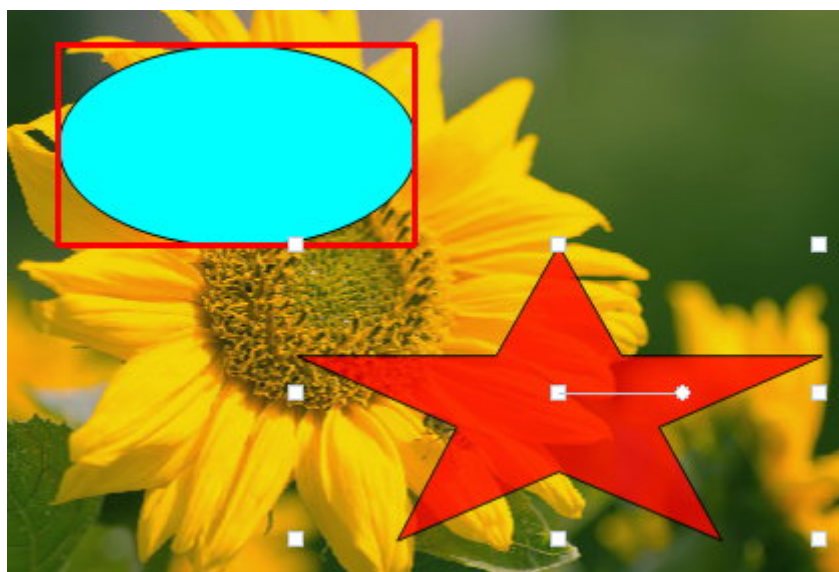

Hold down Alt to align a selected object to another object. The object that is used for alignment will be surrounded with a red box as soon as one of the markers from the selected object touches it. The selected object will then snap to that position. Try out this

feature to get a feel for it.



Hold down Ctrl to center an object horizontally/vertically. The object will snap into position as soon as one of its markers touches the dotted lines. Try out this feature to get a feel for it.

Resizing objects

Drag the border markers to resize objects or the round marker near the center to rotate them.

Rotating objects

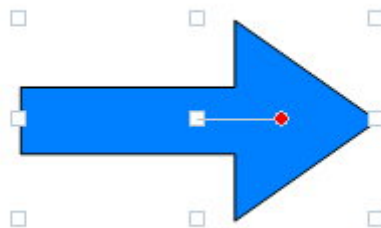

Drag the round marker to rotate an object.

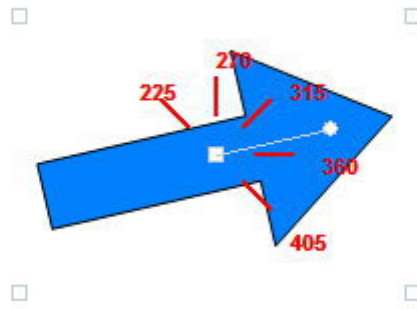

Hold down Ctrl to display visual guides that will help you rotate your object by a specific angle.

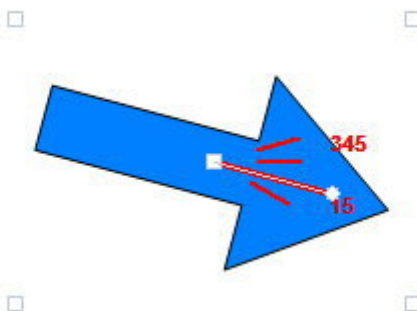

Hold down Alt to display visual guides that allow you to fine-tune your angles.

Context menu

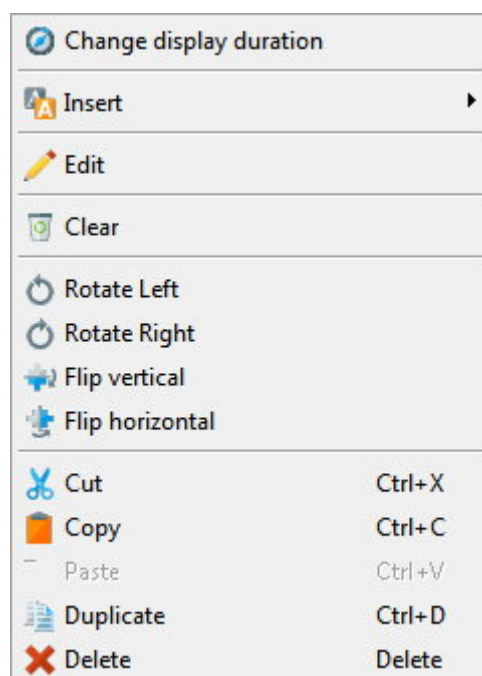

Right-click an image or object to display the context menu. Some features are only

available for objects

Change display duration Displays the picture settings for the current image.

Insert

Text

Creates a new text object with individual font, size and color settings using the [text editor](#).

Circular Text

Wraps text around a circle using the text editor. Once closed, drag the round marker to adjust the angle of the text object.

Table

Creates a table object with the [table editor](#).

Image

Inserts a local image file into your image. The added image will automatically be resized to not fill up the entire workspace. You may freely resize the object if needed.

Shape

Creates a shape object, e.g. a star, with custom outline, filling and transparency settings using the [shape editor](#).

Create reflection

Creates a reflection of the selected element similar to a water reflection. The newly created object cannot be edited directly but will adopt any changes made to the source object,

Edit

Edits the selected object.

Clear

Removes all objects from the current image.

Send to front

Moves the selected object to the highest position in the object hierarchy.

Send to back

Moves the selected object to the lowest position in the object hierarchy.

Rotate Left

Rotates the selected objects 90° left.

Rotate Right

Rotates the selected objects 90° right.

Flip vertically

Flips the selected object vertically.

Flip horizontally	Flips the selected object horizontally.
Cut	Copies the selected objects to the system clipboard and removes them from the image.
Copy	Copies the selected objects to the system clipboard.
Paste	Pastes the most recently copied objects at the current position.
Duplicate	Clones the selected objects.
Delete	Deletes the selected objects.

Context-sensitive buttons

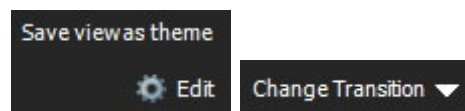

Depending on the position of the playback marker, different buttons will appear in the top right corner of the slide.

- Save view as theme** Stores the current objects and slide settings as a new theme. This allows you to apply custom layouts with various text, graphic and shape objects to other images at the click of a button. You will find these themes under "Your own themes" and may also delete them individually there.
- Edit** Opens the [display settings](#) for the current image.
- Change Transition** Allows you to select a different transition effect.

5.1.2.14 Picture settings

General Settings

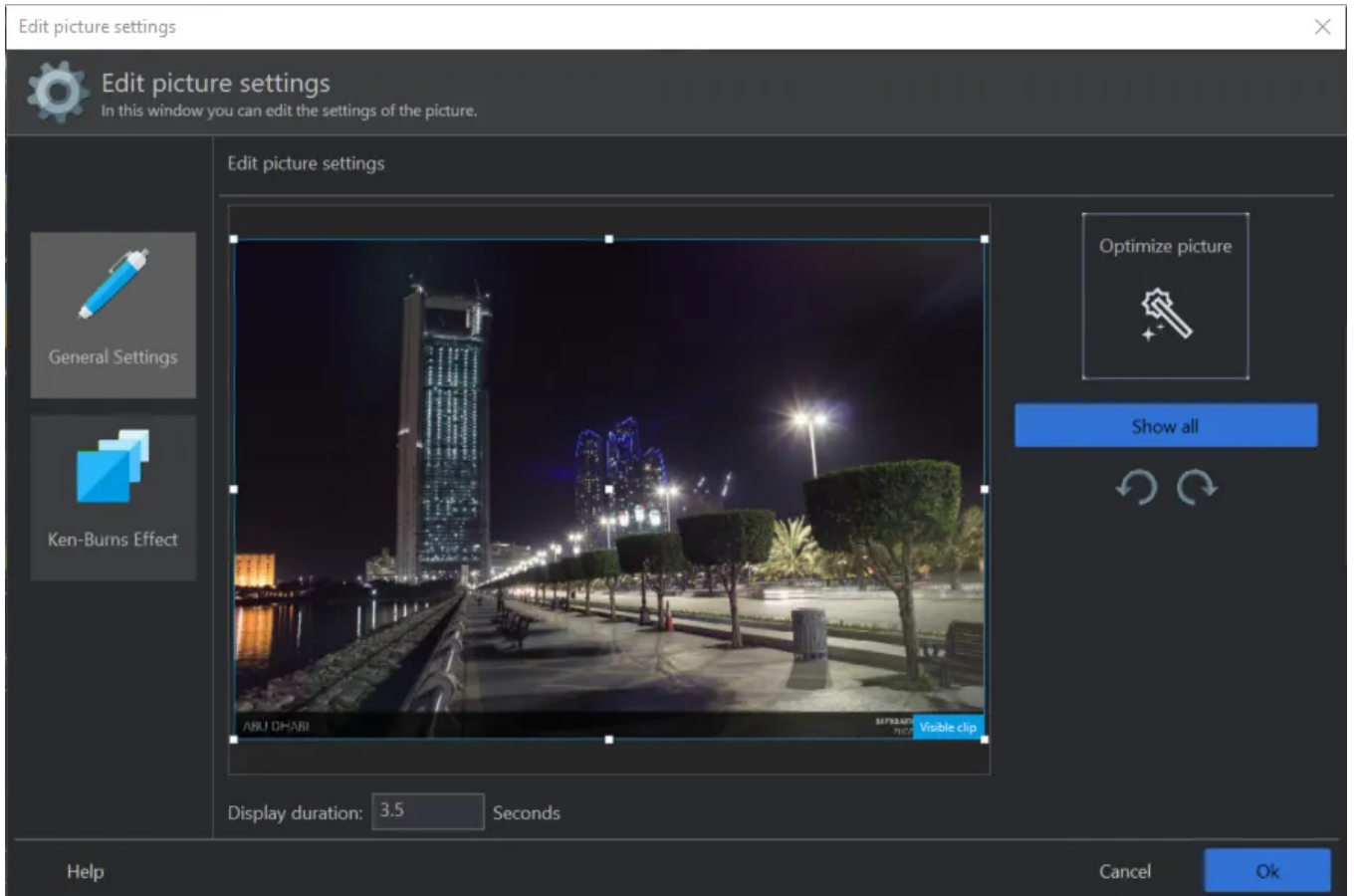

Drag the border markers of the selection rectangle to crop the image. If the selected area is smaller than the image, the program will automatically zoom into it. Use the buttons on the right to rotate the image 90° left/right or to reset the selection. Use the bottom text field to adjust the display duration. "Optimize picture" to toggle automatic contrast, white balance and color optimization for the current image.

Ken-Burns Effect

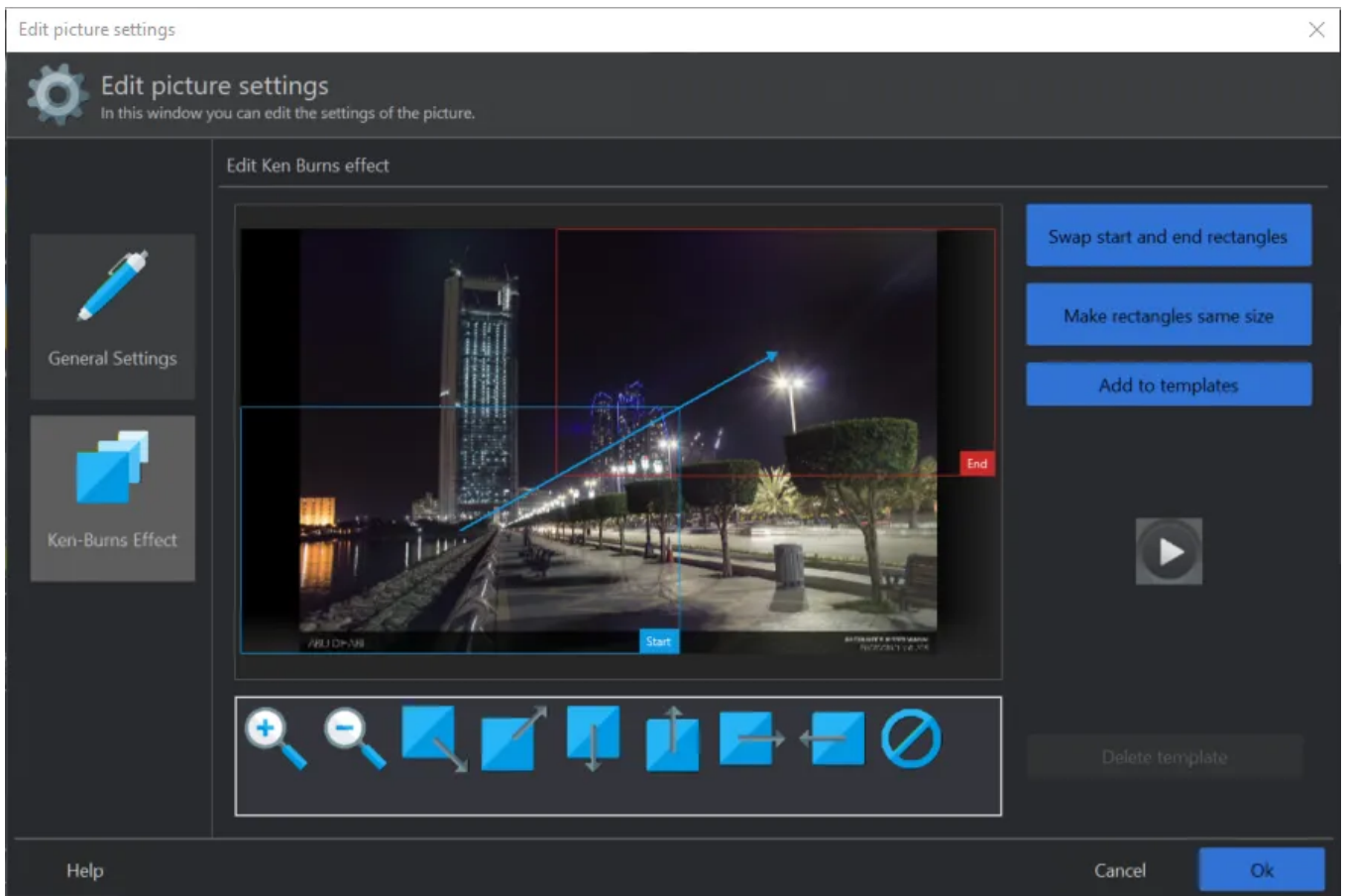

The Ken-Burns effect provides virtual camera panning between a start and end area. You may either adjust these areas manually by dragging their border markers or use the various presets at the bottom. Use the play button to preview your current settings.

- Swap start and end rectangles** Swaps settings between the start and end areas.
- Make rectangles same size** Makes the end area the same size as the start area.
- Add to templates** Saves the current settings as a new template.
- Delete template** Deletes the currently selected preset. Left-click a template to select it.

Presets:

Zoom in, Zoom out, Diagonal pan (top), Diagonal pan (bottom), Vertical pan (top), Vertical pan (bottom), Horizontal pan (left), Horizontal pan (right), No effect

5.1.2.15 Timeline

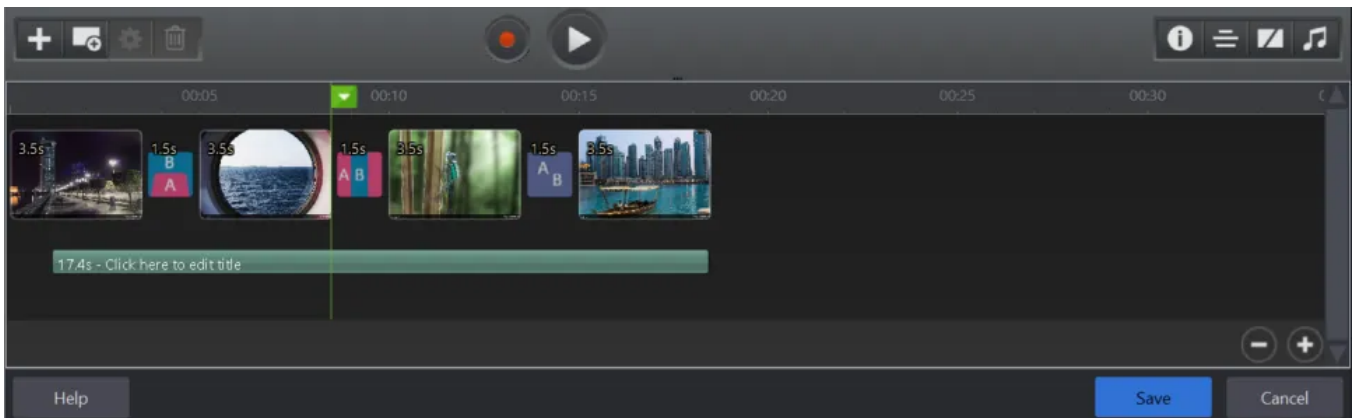

Here is where you can adjust the order of the slides, their transitions and all objects.

Buttons



Add	Adds one or more local images to the project at the current playback marker position.
Add blank item	Adds an empty slide to the project that may for example be used to display additional text information in between slides.
Edit	Opens the display settings for a slide or a transition.
Delete	Deletes the selected elements from the timeline.
Start recording	Allows audio recordings through Windows recording devices, e.g. voice narration.
Play	Plays back the slideshow at the current playback position.
Picture information	Displays additional information such as creation dates or file names in your slides.
Credits	Adds opening/closing credits to your project.
Transition	Specifies transition settings for all slides.
Music	Adds one or more songs to your project as background music .



- Zoom out (-)** Zooms out of the timeline.
- Zoom in (+)** Zooms into the timeline.
- Help** Displays the program help.
- Save** Closes the editor and adds the slideshow to your project.
- Cancel** Closes the editor and discards any changes.

Changing playback positions

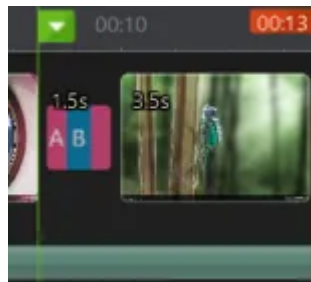

To change the current playback position (green marker) move your mouse to the new position (red marker) and click to place the green marker. Depending on the current playback position, different buttons will become visible.

Timeline elements

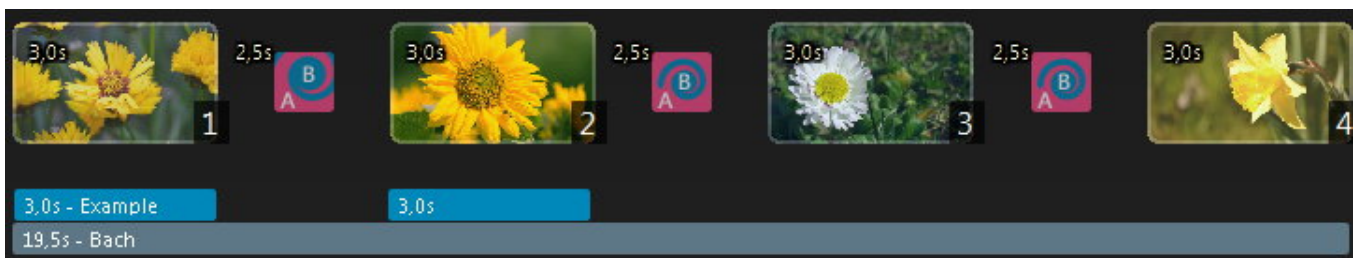

All slideshow elements are displayed as bars of varying lengths, depending on their display durations.

Selecting elements

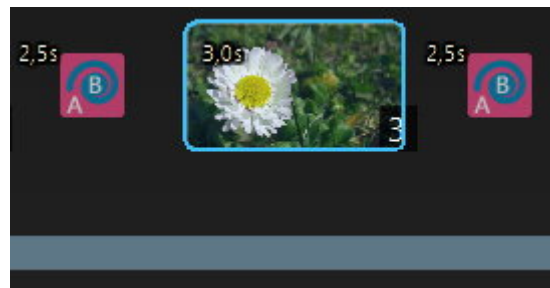

Left-click a timeline element to select it. Hold down Ctrl to select multiple elements sequentially.

Moving elements

Hold down the left mouse button on a timeline element and drag to move it to a new position.

Changing element lengths / display durations



Drag the left/right edge of an element to adjust its display duration. Note that for slide and transition elements, you will have to drag their markers to adjust their display durations.

Context menu

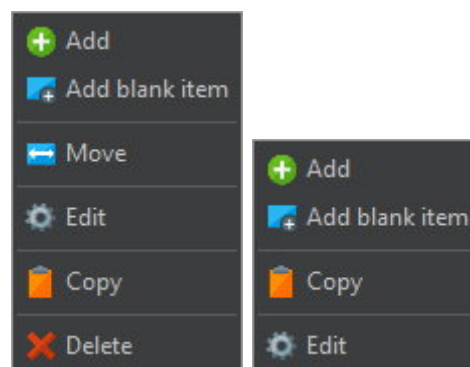

Right click a timeline element or an empty spot in the timeline to bring up the context menu. Some features are only available for certain timeline elements.

Add Adds one or more images to the project.

Add blank item	Adds an empty slide to the project that may for example be used to display additional text information in between slides.
Move	Moves a slide to a new position. More on that here .
Edit	Displays slide or transition settings for these elements. For blank slides , their settings will be opened instead. You may also adjust the display duration for subtitles this way.
Copy	Copies the current Ken-Burns settings for a slide or the transition settings for a transition.
Paste	Applies the previously copied Ken-Burns effect to a slide or replaces an existing transition with a previously copied transition effect.
Delete	Deletes the element from the timeline.

5.1.2.16 Move item

Enter the new position for the selected slide and click "Ok" to apply your setting.

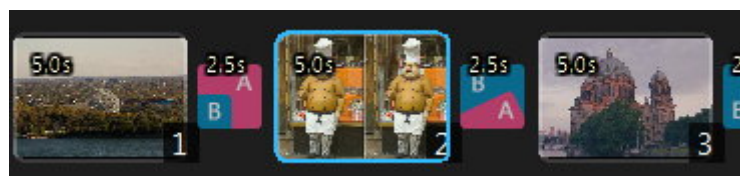

You can see the current index for each slide in the timeline.

5.1.2.17 Edit subtitle element

Use the sliders to adjust the display duration for the selected slide and the duration of its fade in/out effect. The currently selected values will appear centered below each slider.

5.1.2.18 Add multiple images

When adding multiple images, you can specify their sort order. Simply select the desired method and order and click "Ok".

5.1.2.19 Add blank item

Empty slides are ideal to display additional information such as text in between slides.

Single color Fills the slide with a single color.

Gradient Fills the slide with a circular gradient similar to a spotlight using black as start and the selected color as end color.

5.1.2.20 Record

First, specify a name for your recording, then, select the desired recording device. Click "Start test" to check your volume level and "Start recording" to begin the recording process. The process will continue until you click the stop button or slideshow has ended.

5.1.2.21 Show picture information

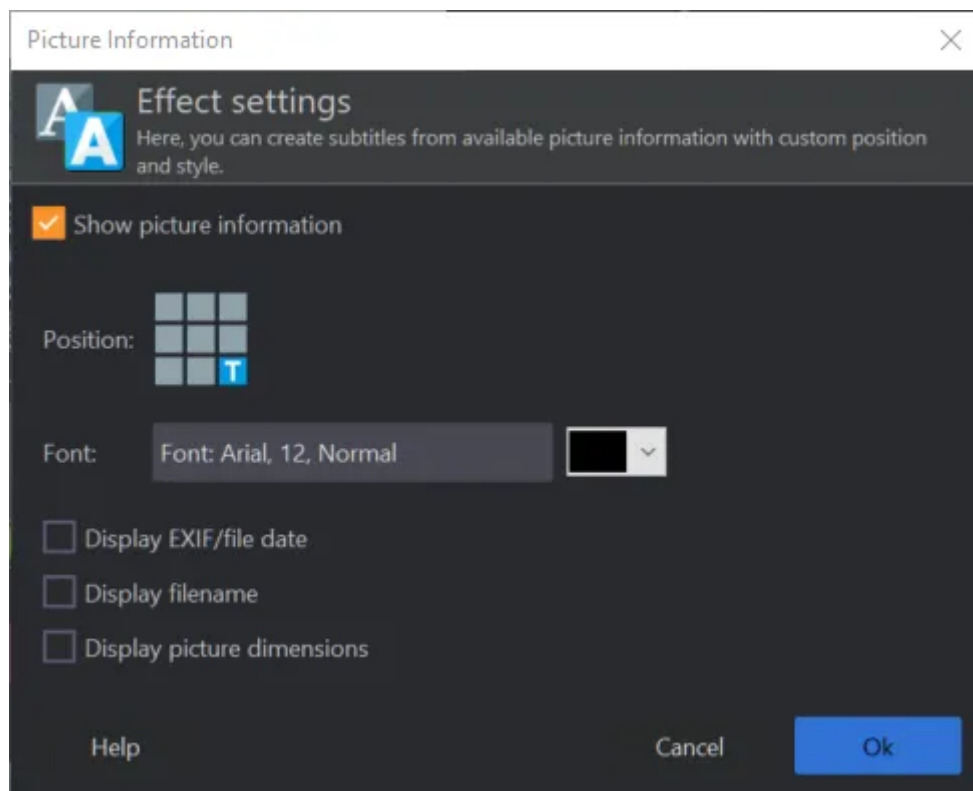

These settings allow you to display additional information such as filenames in your slides.

Position	You can display the information at nine different locations in your slides.
Font	Select your desired font style and color here.
Display EXIF/file date	Enable this setting to display either EXIF dates, if available, or file dates in your slides.
Display filename	Enable this setting to display filenames in your slides.
Display picture dimensions	Enable this setting to display image dimensions, e.g. 1280 x 1024, in your slides.

5.1.2.22 Opening/Closing credits

First, select the type of credits you wish to create.

5.1.2.23 Select type

Then, select a presentation mode. Credits can either appear scrolling on a single page or spread across multiple page transitions.

5.1.2.24 Select background

Adjust the display settings for your credits and use the bottom preview to preview the results. If you use "Use credits as overlay", your credits will be overlaid on top of the first/last slides in your slideshow. Otherwise, your credits will appear as a separate block.

Depending on the [selected type](#), different options become available.

5.1.2.25 Contents: Large scrolling page

In this mode, credits will appear as scrolling on a single page. Use the top left controls to add text, image and shape objects and double-click an entry in the right list to insert a template object. Click

for details on how to work with objects. Use the scrollbar to simulate the scrolling effect to preview your results.

Credits are displayed as blue bars in the timeline that can be resized but not repositioned. Their length affects their playback speed. The shorter they are, the quicker their contents will be displayed. Click to learn how to resize timeline elements. To edit existing credits, either double-click the timeline element or select "Edit" from the timeline context menu.

5.1.2.26 Contents: Multiple fading pages

In this mode, credits are spread across multiple pages. Use the top left controls to add text, image and shape objects and double-click an entry in the right list to insert a template object. Use "Add page" to create additional pages and click a page in the bottom to start editing that page.

Credits are displayed as blue bars in the timeline that can be resized but not repositioned. Their length affects their playback speed. The shorter they are, the quicker their contents will be displayed. Click to learn how to resize timeline elements. To edit existing credits, either double-click the timeline element or select "Edit" from the timeline context menu.

5.1.2.27 Transition

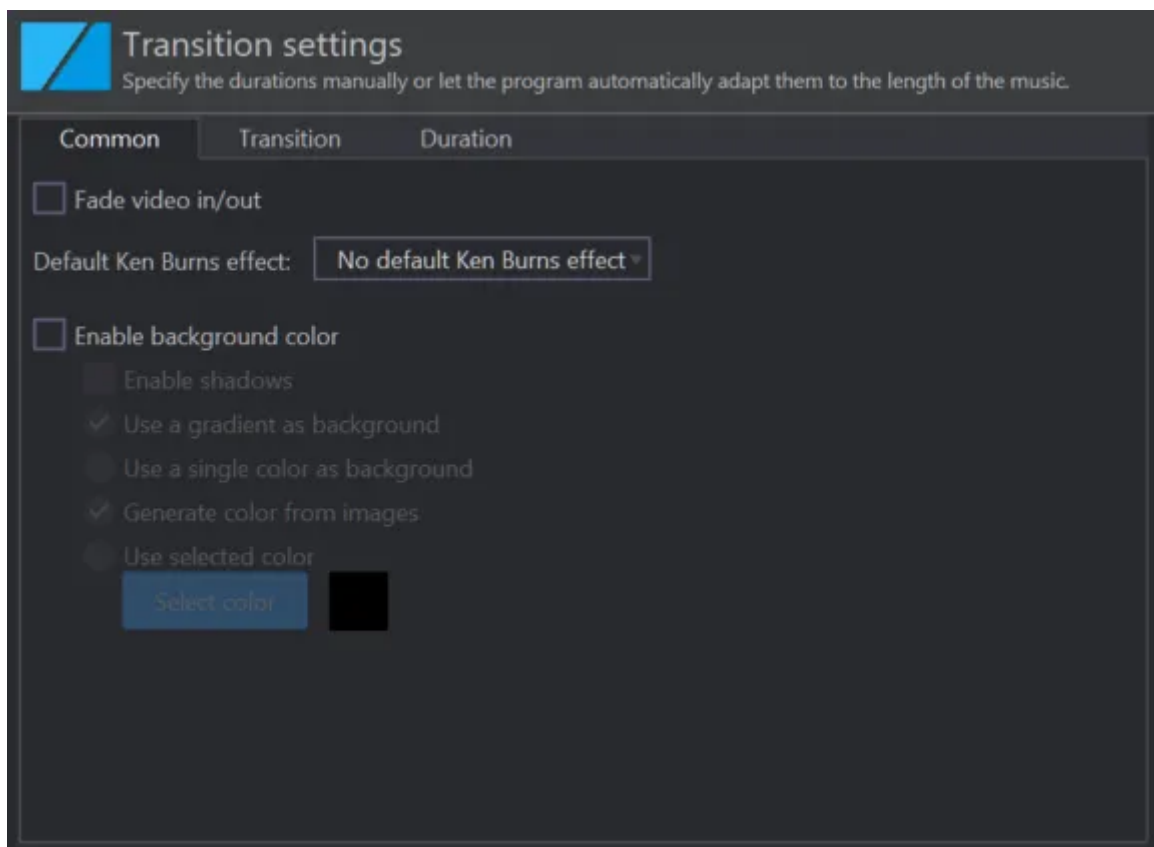

Fade In/Out Video

Enable this setting to fade your video in/out at the beginning/end.

Default KenBurns effect

If enabled, all slides will use a Ken-Burns effect by default. You may also use [individual settings](#) for each slide.

Enable background color

Here, you may select a background color or have the program generate colors based on each image that will be used for the area around a slide. These areas may become visible with some effects such as zooming out as far as possible.

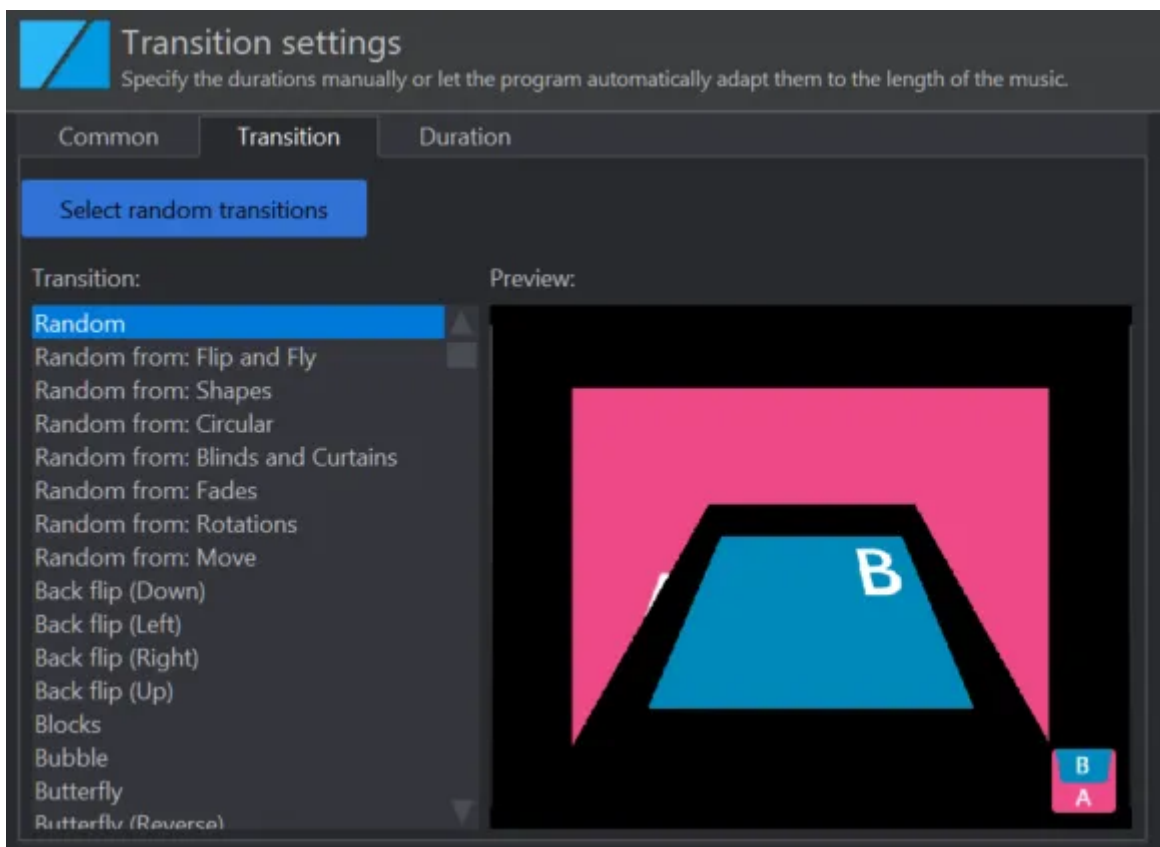

Transitions may either be randomly selected or manually specified. You may further narrow down the number of available effects for the random setting using "Select random transitions". You may still select for each slide. Note that once you click "Ok" this setting will apply to all transitions and will overwrite any existing settings.

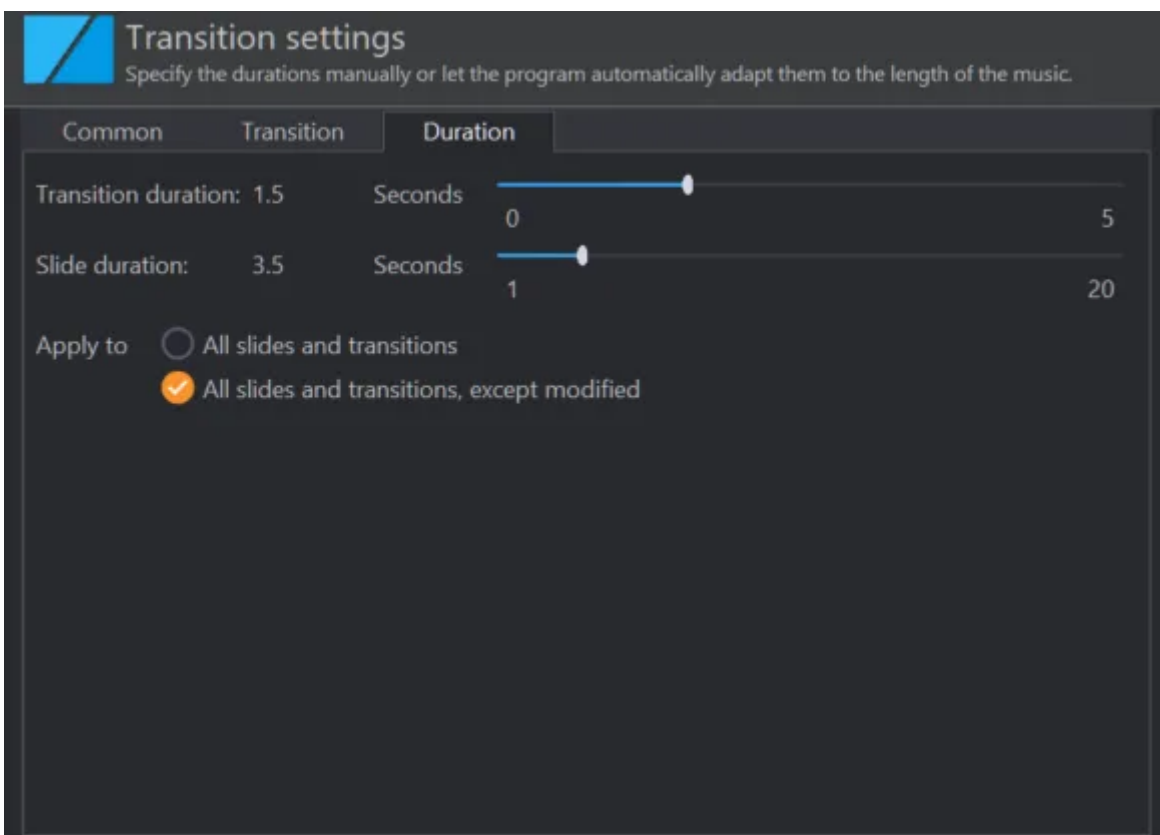

You may select the display duration for transitions and slides here. Use "Apply to" to

specify whether your settings should apply to all or only to slides/transitions, that have not already been modified.

5.1.2.28 Music

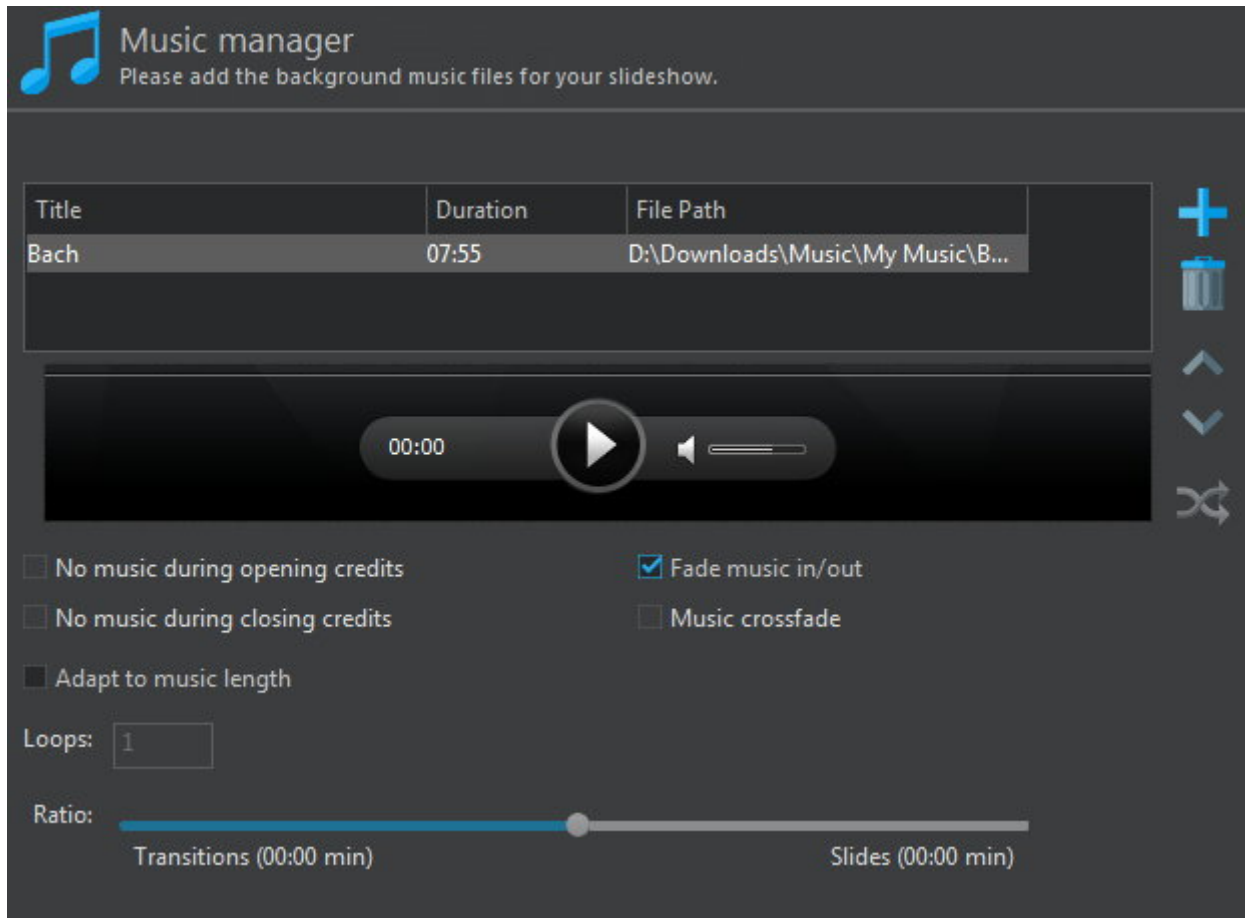

You may add multiple songs to your project as background music

- | | |
|--|---|
| Add | Adds one or more songs to your project. |
| Delete | Removes the selected songs from your project. |
| Move Up | Moves the selected song up by one in the playlist. |
| Move Down | Moves the selected song down by one in the playlist. |
| Random | Shuffles the current playlist. |
| No music during opening credits | Enable this setting to ensure that there will be no music during opening credits. Overlapping music elements will automatically be shifted. |
| No music during closing credits | Enable this setting to ensure that there will be no music during closing credits. Overlapping music |

elements will automatically be shifted.

Music fade in/out

If enabled, songs will be faded in/out at the beginning/end.

Music crossfade

If enabled, songs will fade into each other without gaps.

Adapt to music length

Use this setting to specify how much playback time will be used for transitions and how much will be used for slides. Use the slider to adjust your setting.

Example:

Transitions (00:05 min) - Slides (00:08 min)

This would mean that 5 seconds of the total music length would be used for each transition and 8 seconds for each slide.

5.1.2.29 Select transition

Use this dialog to select the effect that will be used between the current and the following slide. Use the dropdown menu at the top to narrow down the list based on categories.

5.1.2.30 Themes

Slideshow Studio comes with various logos, subtitles and music effects to add more life to your slideshows. These elements behave like and will also show up as elements in the

. Use the dropdown menu to select a categories and double-click an item to apply it to your project. Note that any existing logos/subtitles will be replaced as soon as you add a new item.

Theme These are logo + subtitle combinations.

Logos This section contains various logos.

Subtitle This section contains subtitles with customizable texts. Note that subtitles are a combination of images and text objects. To move a

subtitles, you will therefore have to select both objects to avoid them drifting apart.

Music effect This section offers multiple sound effects, e.g. applause.

Your own themes

Select "Your own themes" from the dropdown menu to view your customized themes. Double-click an item to add its objects to your project or use "Delete theme" to delete it.

Recording

[Your recordings](#) are listed here. Double-click an item to add it to your project or use "Delete recording" to delete it.

5.1.2.31 Settings: View

- | | |
|---------------------------------|---|
| Safe zones | Enable this option to ensure subtitles remain within the display boundaries of most TVs. |
| Wrap timeline | If enabled, the timeline will be wrapped into the next line as soon as its elements exceed the available display width similar to how a text editor wraps characters at the end of a line. If disabled, all elements will be displayed in a single line with horizontal scrolling, if needed. |
| Text editor default font | This is the default font setting for new subtitle elements. |

5.1.2.32 Settings: Duration

- | | |
|---------------------------------|---|
| Element display duration | This setting will be used for newly created elements, e.g. subtitles. The currently selected value will be displayed in the center below the sliders ("3s" in this case). |
|---------------------------------|---|

Fade in-/out duration

This is the amount of time that will be to fade elements in/out. The currently selected value will be displayed in the center below the sliders ("4s" in this case).

5.1.3 Creating menus

Select a design or click "Use no menu" to avoid creating a disc menu.

5.1.3.1 Editing the design



The disc menu allows you to quickly navigate between chapters and scenes later. The program will auto-insert video previews for the included videos.

Toolbar

Undo

Undoes the last operation.

Redo	Redoes the last undone operation.
Cut	Cuts the current object and copies it to the system clipboard.
Copy	Copies the current object to the system clipboard.
Paste	Pastes the currently copied object into the menu.
Duplicate	Creates a copy of the selected object.
Delete	Deletes the selected object.
Zoom all Objects	Adjusts the zoom so that all objects are visible on the screen.
Zoom In	Zooms into the design.
Zoom Out	Zooms out of the design.
Zoom selection	Zooms into the selection.
Send to front	Sends the selected object to the front.
Send to back	Sends the selected object to the back.
Rotate left	Rotates the selected object 90° left.
Rotate right	Rotates the selected object 90° right.
Mirror vertically	Mirrors the selected object vertically.
Mirror horizontally	Mirrors the selected object horizontally.
Acquire image	Allows you to import an image. More on that here .
Preview	Displays a functional preview of the current menu page.

Working with objects

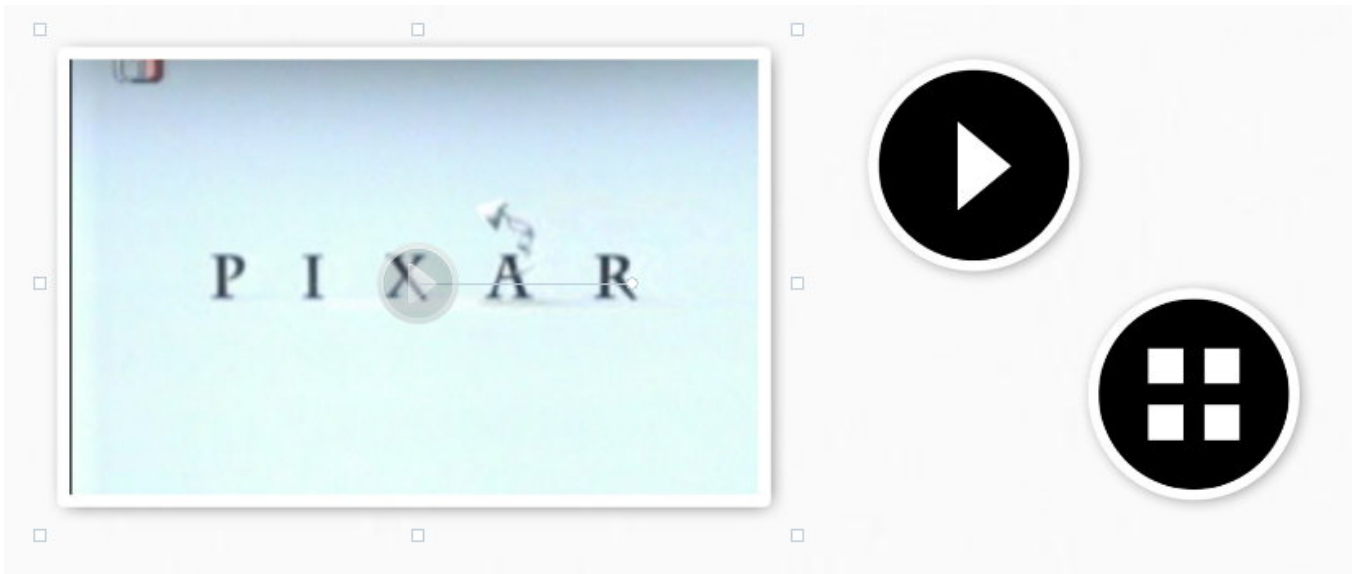

Click an existing object to select it and drag the surrounding markers to adjust its size. Drag the center marker to adjust its position. Drag the circular marker to adjust the angle. Hold down Alt or Ctrl while dragging to align an object either with existing objects or the center point of your menu.

Background Adds a background image to the current page.

New Image Inserts an image as object into the menu.

New Text Allows you to add text objects using the [text editor](#).

New Shape Allows you to add shape objects using the [shape editor](#).

Editing properties

Double-click an object to edit its. Click [here](#) to learn more about button properties. Click [here](#) to learn more about the properties of video preview objects. You may also use the context menu to [manually adjust the location of an object](#).

Editing pages

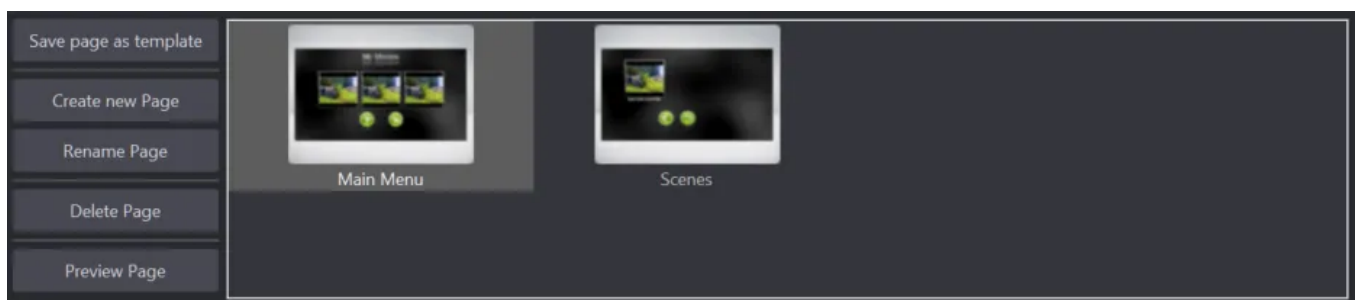

Each page can hold its own video previews and button controls. Make sure to include at least one navigation button on each page for easy navigation.

Save page as template	Saves your current design as a template. You will find your templates under "Your own themes" under the "Themes" tab.
Create new Page	Creates a new menu page. More on that herw .
Rename Page	Renames the current page. More on that here .
Delete Page	Deletes the current page. The main page cannot be deleted.
Preview Page	Displays a functional preview of the page.

Templates

Buttons	Double-click a design to create a button. By default, the button will be added in the top left corner of the current page.
Themes	Double-click a design to adjust the appearance of all objects on the current page. Use the top dropdown menu to switch between included themes and your own themes.
Movies	Double-click a movie to create a preview object. By default, the object will be added in the top left corner of the current page.
Music	Click "Play music" to preview the current background music and click "Edit background music" to select different songs .

5.1.3.2 Editing properties

Use the text fields to adjust the position and size of the selected object.

5.1.3.3 Editing buttons

Use this dialog to select the action that will be triggered when you press the associated button. Buttons can be used to play all/individual movies or for navigation.

5.1.3.4 Editing video previews

Select the video to be used by the preview.

5.1.3.5 Editing background music

You may select a background music for your slideshow here. Use the slider to adjust the music duration.

5.1.3.6 Adding pages

Input a name and select a design for your new page or select "Use no design". Make sure to add a navigation button later.

5.1.3.7 Editing pages

Just input the new name for the page.

5.1.4 Selecting a target

You can either write your movie to disc or export it to a folder, e.g. to burn it with "[DVD from folder](#)" later.

5.1.5 Encoding

In this step, the program will render your movie either to disc or to a folder. This procedure may take a while depending on your system specs.

5.2 Create Movie / Slideshow Blu-ray

Input a name for your project and select an output format. The remaining steps are identical to [Create Movie / Slideshow DVD](#).

5.2.1 Selecting a format

Usually, you don't have to adjust the TV system settings as the program will pick a suitable setting for your region automatically.

5.3 Video DVD from Folder

1. Input a title and select the folder that contains the required files for the video DVD.

The folder must have the following structure:

Folders:

```
\BDMV
\BDMV\AUXDATA
\BDMV\BACKUP
\BDMV\BACKUP\BDJO
\BDMV\BACKUP\CLIPINF
\BDMV\BACKUP\JAR
\BDMV\BACKUP\PLAYLIST
\BDMV\BDJO
\BDMV\CLIPINF
\BDMV\JAR
\BDMV\META
\BDMV\PLAYLIST
\BDMV\STREAM
\CERTIFICATE
\CERTIFICATE\BACKUP
```

Files:

```
\BDMV\index.bdmv
\BDMV\MovieObject.bdmv
```

The light gray directories can also be created by the program itself.

2. [Select your disc recorder and burning settings.](#)

3. Start burning.

5.4 Video Blu-ray from Folder

1. Input a title and select the folder that holds the files required to create a Blu-ray video disc.

2. [Select your disc recorder and burning settings.](#)

3. Start burning.

5.5 Video CD (VCD)

Enter a title and select the videos to be included on your disc. Then, [select your disc recorder and burning settings](#) and start burning.

5.6 Super Video CD (SVCD)

Enter a title and select the videos to be included on your disc. Then, [select your disc recorder and burning settings](#) and start burning.

6. Covers + Inlays

First, select the cover types and formats you wish to use. You may also [specify your own paper format](#) or edit an existing entry using the pencil icon. "[Acquire image](#)" allows you to select a background image for your cover. Either click the plus icon or drag the image into the designated area to the right of the list of available formats. To adjust the [disc diameter](#), use the disc icon below the pencil icon for the "Disc" section.

6.1 Edit paper formats

You may adjust an existing format or create your own in case the ones included do not match your printer or your format is not listed. The included formats are write-protected but you may use "Copy" to create an editable copy from an existing format.

6.1.1 Copy / New / Edit

First, input a name for the new format and specify its measurement. Select "Custom" to manually specify a width and height. Then, select the media type and specify the number of pages and orientation. You will then need to specify the number of entries for each printed page.

6.1.1.1 Defining items

Select type and quantity and click "Next" to proceed.

6.1.1.2 Defining measures

Depending on your selected type, you will either see the first or the second dialog. Click the text fields to update the preview accordingly. The hint at the bottom provides additional infos.

6.1.1.3 Summary

Finally, you will see a summary of your inputs. Click "Finish" to apply your settings.

6.2 Change Disc Radius

Use this dialog to adjust the size of the printable area on your disc.

6.3 Editing titles

Either input the song titles manually or use "Import" to load the data from an existing disc.

6.3.1 Edit entry

Use this dialog to edit the details of a song title. Use "Clear thumbnail" to remove an existing cover and "Load thumbnail" to select a new cover image. Use "← Previous" and "Next →" to navigate between multiple selected songs.

6.4 Creating a design

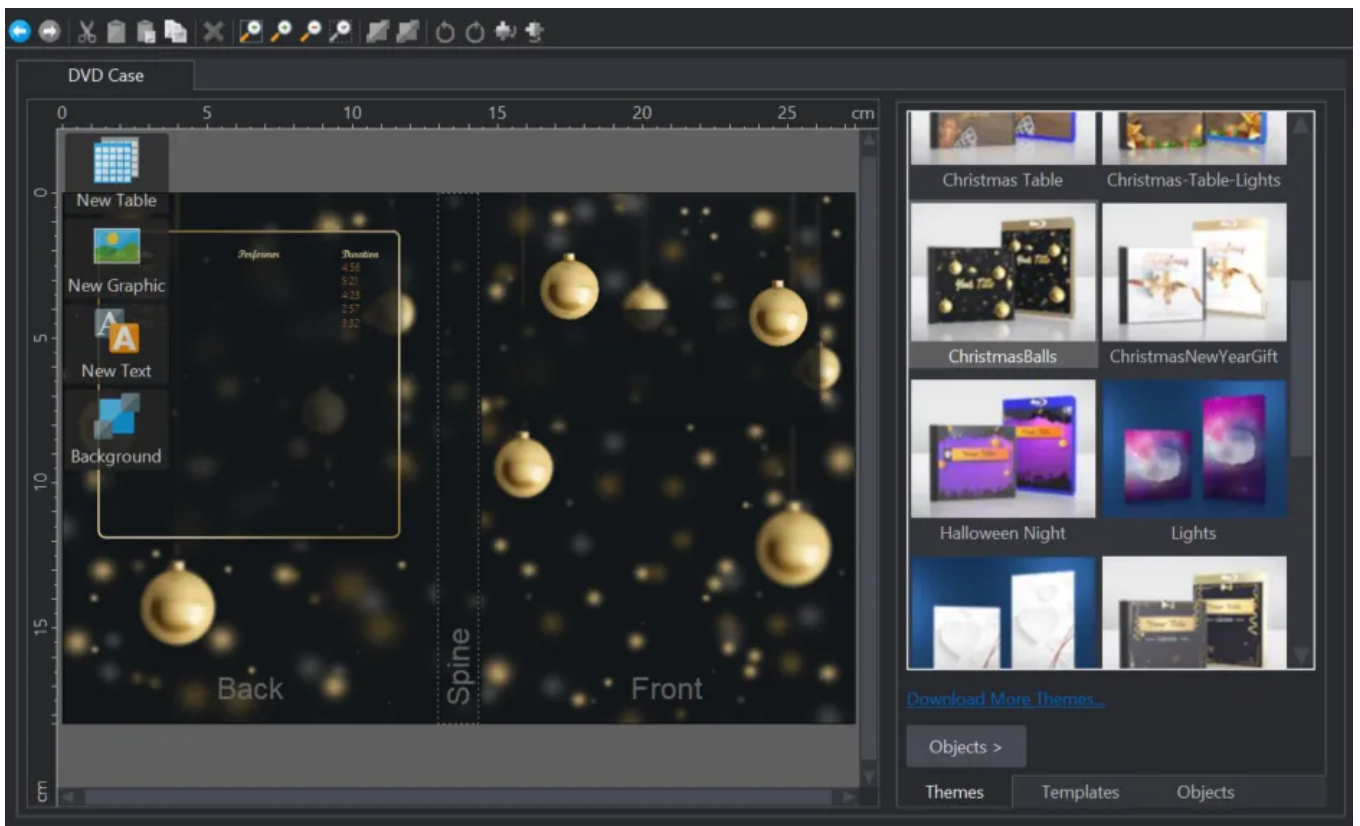

The program will automatically create a mosaic view from all your existing cover images.

Toolbar

New project	Discards the current design and starts over.
Open project	Loads an existing project.
Save project	Saves the current project.
Undo	Undoes the last operation.
Redo	Redoes the last undone operation.
Cut	Cuts the current object and copies it to the system clipboard.
Copy	Copies the current object to the system clipboard.
Paste	Pastes the currently copied object into the menu.
Duplicate	Creates a copy of the selected object.
Delete	Deletes the selected object.

Zoom all Objects	Adjusts the zoom so that all objects are visible on the screen.
Zoom In	Zooms into the design.
Zoom Out	Zooms out of the design.
Zoom selection	Zooms into the selection.
Send to front	Sends the selected object to the front.
Send to back	Sends the selected object to the back.
Rotate left	Rotates the selected object 90° left.
Rotate right	Rotates the selected object 90° right.
Mirror vertically	Mirrors the selected object vertically.
Mirror horizontally	Mirrors the selected object horizontally.

Working with objects

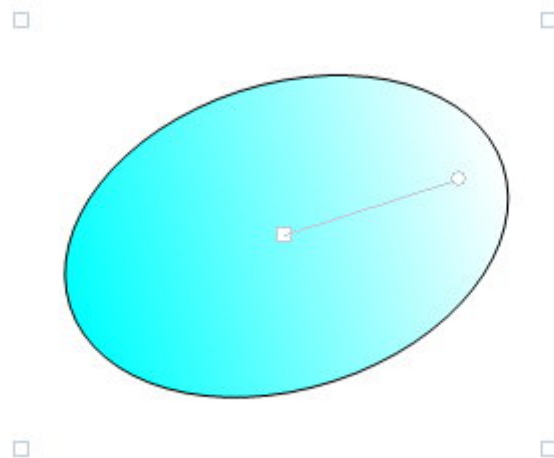

Click an existing object to select it and drag the surrounding markers to adjust its size. Drag the center marker to adjust its position. Drag the circular marker to adjust the angle. Hold down Alt or Ctrl while dragging to align an object either with existing objects or the center point of your menu.

New Table	Creates a table object. Double-click the object to open the table editor.
New Graphic	Allows you to insert an image or shape object. More on shapes here .

- View Text** Create a text object using the [text editor](#). Adjust the size of the object to modify the angle for circular texts.
- Background** Adds a background image based on a local file, cover search or the [mosaic feature](#).

Themes

Themes help you quickly adjust your design through a simple double click. All data from the is retained.

Templates

This view holds your saved designs which work the same way as templates. Right-click an existing template to display the context menu.

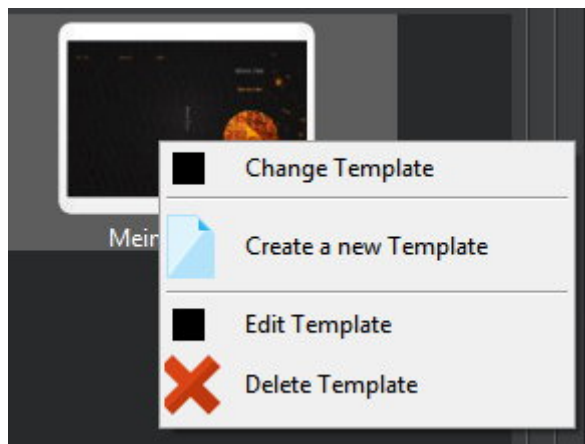

- Change Template** Applies the selected template to the current project.
- Create a new Template** Allows you to create a new template. More on that [here](#).
- Edit Template** Edits the selected template. More on that [here](#).
- Delete Template** Deletes the selected template.

Objects

This view helps you keep track of and select existing objects quickly. Simply click an entry to select the associated object,

6.4.1 Mosaic cover

The mosaic itself is created automatically from all available cover images. Use the slider to adjust the brightness and click "Randomize mosaic" to create a different mosaic.

6.4.2 Creating / Editing templates

Use Template Editor to modify existing templates or create new ones. The procedure is identical to [creating cover designs](#).

6.5 Printing covers

This view shows all the sheets you created. Click "Print" above each sheet to print that sheet. Enable "With Cutmarks" to include marks that will make it easier to cut out your designs later using scissors.

6.6 After printing

Click "Save as template" to save your design and later.

7. Copy Disc

1. [Select the drive that holds the disc to be copied.](#)
2. [The program will begin reading the disc.](#)

3. [Select a disc recorder and settings.](#)

4. Start burning. The [status](#) will be presented visually.

Note: The program supports "on the fly" copies. In this case, data won't be buffered on your hard disk but immediately written to the target disc. Note that your source drive has to be fast enough to provide a constant data stream, otherwise, the process may fail and render the target disc unreadable.

7.1 Reading status

The program will now read the disc and provide visual feedback.

8. Disc Image

8.1 Burn Image

1. [Select the image file to be burned.](#)
2. [Select a disc recorder and settings.](#)
3. Start burning.

8.2 Create Image

1. [Select the drive that contains the disc.](#)
2. Select the output location and format.
3. The program will now create the image file and give visual feedback.

8.2.1 Write status

The status of the image creation is presented visually.

8.3 Browse Image

First, select the image you would like to browse.

8.3.1 Selecting files

Use the tree view to select entire folder structures and the center pane to select individual files. Use the arrow button at the bottom right to show/hide the preview pane.

Open Allows you to open a different image file.

Extract Extracts the selected files/folders to a selectable target location.

9. Backups

9.1 Backup Files

First, select files and folders to backup. To select a file/folder, click the checkbox in front of it. Select a folder in the tree view, to select all subfolders and folders.

Edit Exclusion Rules...

Exclusion rules allow you to prevent files of specific file types from being backed up. The default rules cannot be edited and should not be deleted.

New	Allows you to exclude a file type, e.g. .TXT, from all backups. You may either select the type to exclude from a list or enter its extension into a text field manually.
Default Rules...	Restores the default rules.
Edit	Allows you to edit a rule.
Remove	Deletes a rule.
Close	Closes the dialog.

The next step is to specify the [output location and further settings](#) for your backup(s).

9.1.1 Selecting backup settings

You can either backup your files to disc or to hard disk, flash drive or another external device. You may also protect your backup with a password and compress it to save space. If required, you may even split up your backup into several smaller files of equal size. Ashampoo Burning Studio 25 can also remind you to regularly back up your files. Note that, for the reminder to work, the program has to be running.

9.2 Manage Backups

Available backup plans are listed on the left with their associated back ups in the center, when selected. Use "Add backup file manually" to add backups from another source. Note that manually added backups will always be listed under "Unknown projects". Use "Create this backup again" to use the existing settings to back up the affected files again. Click "Restore backup" to restore all or individual files from the selected backup.

9.2.1 Restore files

Select files/folders to restore. Use the tree view to select entire folder structures and the

center pane to select individual files.

9.2.1.1 Settings

Your files can either be restored to their original or a custom location. Furthermore, you can specify how the program will handle existing files that match the backup in file names.

9.3 Backup External Devices

The program comes with presets for common device categories (USB stick, USB disc recorders, cell phones). The procedure is always the same.

First, select whether you wish to create a new backup disc or update an existing one.

9.3.1 Create a new backup

The program will scan your system for suitable data sources and will display them in the left tree view. Select a device or subfolder to backup there. Then, select the file types you wish to backup.

9.3.1.1 Scanning files

The program will now scan for suitable files and have you in the next step. The files will then be burned to disc.

9.3.2 Update an existing backup

First, insert the disc that contains the previous backup. The remaining steps are identical to those for [creating a new backup](#).

10. Advanced Functions

10.1 Create a modified copy

1. Select the drive that contains the disc to be modified.
2. [Select files and folders to be added.](#)
3. Start burning.

10.2 Create a Data Disc using advanced settings

Advanced users may use this feature to adjust file system settings or create a bootable disc. Note that the Ashampoo Burning Studio 25 does not provide a boot image itself.

1. Select your desired file and boot settings.
2. [Add files and folders.](#)
3. Start burning. The current [status](#) will be presented visually.

ISO 9660

Format	Capabilities
ISO 9660 - Level 1	File and folder names with up to 8 characters, no special characters except underscore, 8 folder levels max
ISO 9660 - Level 2	File and folder names with up to 31 characters, various

	special characters, 8 folder levels max
ISO 9660 - Windows (Romeo)	File and folder names with up to 128 characters, various special characters, unlimited number of folder levels

Joliet

Joliet supports file names with up to 64 characters with support for various special characters, there's no limit on the number of folder levels.

UDF

Universal Disc Format (UDF) was developed for high-capacity media such as DVD and Blu-ray. There's no restrictions on file name lengths and folder levels.

UDF Format	Use Case
UDF 1.02	All DVD players
UDF 1.50	Rewritable CDs / DVDs
UDF 2.50	Rewritable Blue-ray discs
UDF 2.60	Standard Blue-ray discs

Bootable CD/DVD/Blu-ray discs

Note that you require a boot image that contains all files and folders required for booting such as images of already bootable CDs.

Additional information

By default, Burning Studio will use the most compatible mode.

Data projects:

CD: ISO9660 Level 1 and Joliet

DVD & Blu-Ray: ISO9660 Level 1, Joliet and UDF 1.02
For files > 4GB (4294967296 Bytes) only UDF 1.02

Video DVD:
ISO9660 Level 1, Joliet and UDF 1.02

Video Blu-ray:
UDF 2.50

Autostart discs:
UDF1.02

10.3 Erase rewritable Disc

1. Select the disc recorder that holds to the disc to be erased. Select "Quick Erase" to erase the table of contents only. The disc will still be fully writable then but previous files may be retrievable through special recovery tools. This may pose a problem should the disc contain sensitive information and should fall into the wrong hands.
2. Start the erasing procedure. The current status will be presented visually.

10.3.1 Status

The status will be presented visually.

10.4 Finalize Disc

Some older drives cannot read non-finalized discs. Use this feature to finalize unfinalized discs.

1. Select your disc recorder and begin the process.
2. The status will be shown visually.

10.5 Analyze Medium

This function displays various details on the inserted disc, e.g. number of blocks.

10.6 Statistics

Information on the number of burned disc and created tracks is available here.

| 11. Settings

11.1 General Options

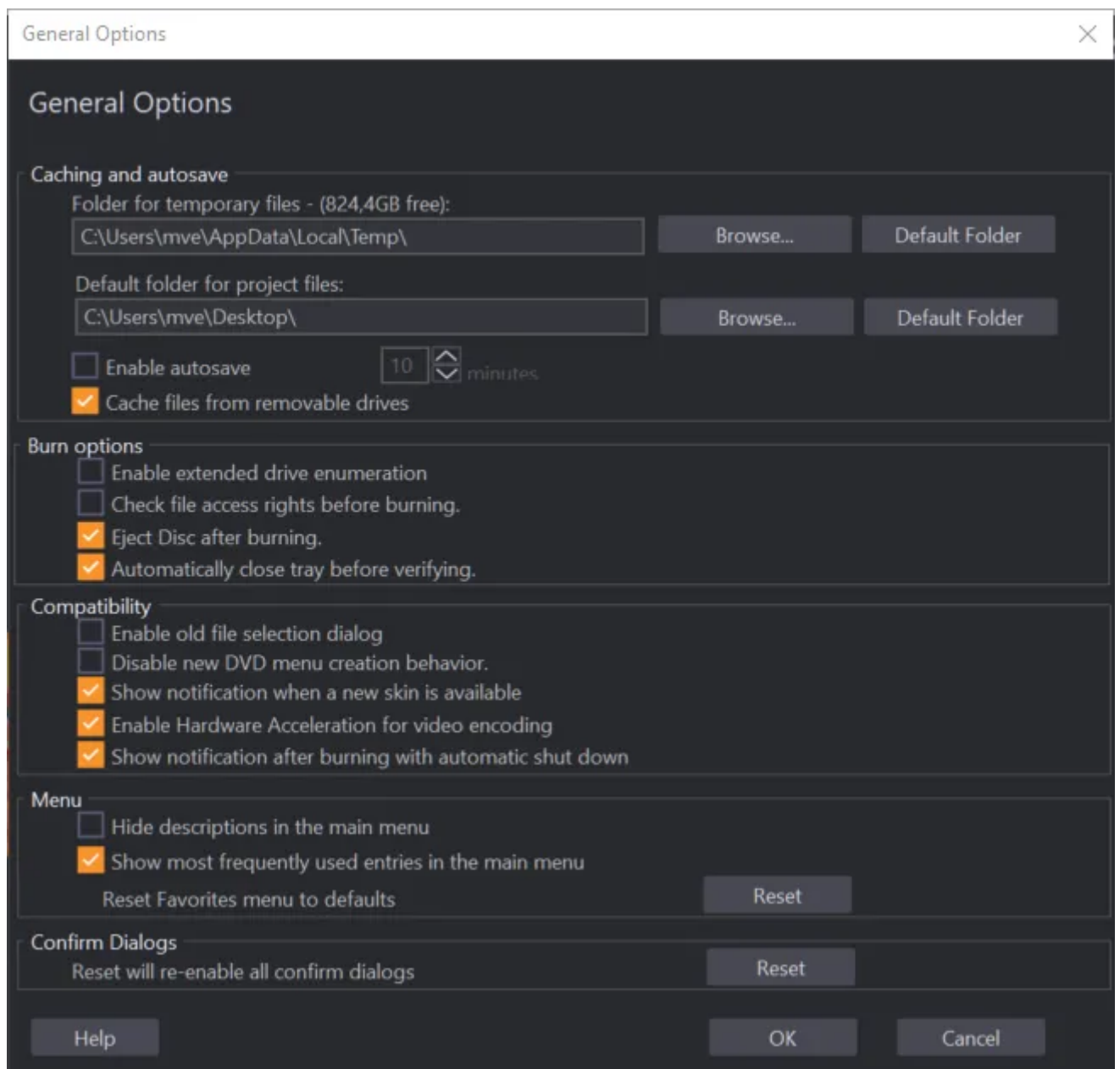

Caching and autosave

Select a folder for all temporary files and specify a directory that will be used for automatic saves. Enable autosave, to have the program back up your projects at regular intervals. You can also enable/disable intermediate file caching here.

Burn options

Enable extended drive enumeration

Enable this setting in case the program doesn't detect your disc recorder.

Check file access rights before burning	Enable this setting to have the program check it has access to all files before burning them to avoid errors.
Eject Disc after burning	If enabled, the drive will open automatically once burning is complete.
Automatically close tray before verifying	If enabled, the drive will close automatically before disc verification commences. Enable this setting if you enabled the one above it and you want your discs to be verified once they are burned.

Compatibility

Enable old file selection dialog	Enable this option in case the program often hangs or freezes when you try to select files. This will force the program to use the classic Windows file chooser instead of Burning Studio's proprietary one.
Disable new DVD menu creation behavior	If enabled, DVD/Blu-ray players will not return to the disc menu once a clip has finished playing but play the next clip instead.
Show notification when a new skin is available	Enable this setting to get notified whenever new program skins become available.
Enable Hardware Acceleration for video encoding	If enabled, the program will use the GPU to speed up video encoding.
Show notification after burning with automatic shut down	Displays a notification message before the computer is shut down

after the burning process is complete.

Confirm Dialogs

Click "Reset" to display all program notifications again.

11.2 Change Skin

Skins let you change the visual appearance of Burning Studio.

- Create** Allows you to create a new skin. First, input a title and select a background image and position. Use the bottom slider to adjust the color of the program header.
- Delete** Deletes the selected skin.
- Import** Imports an existing Burning Studio skin from a file.
- Export** Exports the selected skin to a file.
- Download** Allows you to download additional program skins.

12. Service

- Software Deals** Opens a page with current Ashampoo bargains in your browser.
- More Downloads** Opens a page with Ashampoo product download links in your browser.
- License status** Verifies the status of your program license and allows you to active the program or obtain additional discounted licenses.

Check for updates...	Checks whether a newer program version is available.
Contact support...	Displays a contact form that allows you to contact our customer service.
Troubleshooting	Displays a list of solutions for common program-related issues.
Service settings	Allows you to configure service notification settings.